

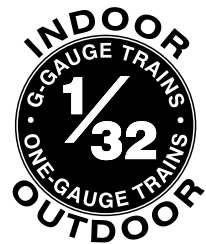

# F-Unit A-Unit Diesel Engine Set OPERATOR'S MANUAL

## **Compatibility**

This locomotive is capable of operating with DC or AC power supplies (See page 29 for a complete list of compatible transformers and wiring instructions.) indoors or outdoors. MTH does not recommend operating the locomotive in inclement weather and strongly suggests that it not be left out in the elements. The locomotive will negotiate a R1 G-Gauge track. Additional features may be utilized when controlling the engine with MTH's Digital Command System (DCS).



PLEASE READ BEFORE USE AND SAVE  
[www.railking1gauge.com](http://www.railking1gauge.com)

# Table of Contents

<b>Set Up Checklist</b> .....	3
Locomotive Coupler Installation.....	3
Setup for R-2 & Larger Curve.....	5
Lubrication.....	6
Priming The Smoke Unit.....	6
Checking the Battery.....	7
Placing The Engine On The Track.....	7
Installing the Locomotive Pilot Details.....	8
<b>Basic Operation</b> .....	9
Activating Features Using DC Power.....	9
Using DCS with DC Power.....	10
DCS Polarity Switch.....	11
Activating Features Using AC Power.....	12
<b>Proto-Sound® 2.0 Operating Instructions</b> .....	13
Activating Proto-Sound® 2.0 Conventional Mode Features.....	13
Freight Yard Sounds (FYS) or Passenger Station Announcements (PSA):.....	14
Proto-Coupler Operation.....	15
Speed Control.....	16
Locking Locomotive Into A Direction.....	17
Reset To Factory Default.....	17
Automatic Sound Effects.....	17
<b>Maintenance</b> .....	18
Lubricating and Greasing Instructions.....	18
Traction Tire Replacement Instructions.....	19
Light Bulb Replacement Instructions.....	20
Self Charging Battery Back-Up.....	22
ProtoSmoke™ Unit Operation.....	23
Installing the Locomotive Pilot.....	24
Troubleshooting Proto-Sound® 2.0 Problems.....	25
Transformer Compatibility and Wiring Chart.....	28
Recommended AC Transformers.....	29
Additional Features Accessible With The DCS System....	30
Service & Warranty Information.....	31
Limited One-Year Warranty.....	31

**CAUTION: ELECTRICALLY OPERATED PRODUCT:**

Recommended for Ages 14 and up. Not recommended for children under 14 years of age without adult supervision. As with all electric products, precautions should be observed during handling and use to prevent electric shock.

**WARNING:** When using electrical products, basic safety precautions should be observed, including the following:

Read this manual thoroughly before using this device.

- M.T.H. recommends that all users and persons supervising use examine the hobby transformer and other electronic equipment periodically for conditions that may result in the risk of fire, electric shock, or injury to persons, such as damage to the primary cord, plug blades, housing, output jacks or other parts. In the event such conditions exist, the train set should not be used until properly repaired.
- Do not operate your layout unattended. Obstructed accessories or stalled trains may overheat, resulting in damage to your layout.
- This train set is intended for indoor use. Do not use if water is present. Serious injury or fatality may result.
- Do not operate the hobby transformer with damaged cord, plug, switches, buttons or case.

This product may be protected by one or more of the following patents: 6,019,289; 6,280,278; 6,281,606; 6,291,263; 6,457,681; 6,491,263; 6,604,641; 6,619,594; 6,624,537; 6,655,640.

©2010, M.T.H. Electric Trains®, Columbia, MD 21046

# Set Up Checklist

- Install the locomotive couplers
- Lubricate the locomotive
- Prime the smoke unit
- Check to see whether the batteries need to be charged for full sound effects
- Apply power to run as described in the Basic Operating Section of this manual
- Installing Pipe Details

## Installing The Locomotive Couplers

This RailKing One-Gauge locomotive is designed to accept 5 different types of G-Gauge couplers - an MTH Remote Control Proto-Coupler™, an operating knuckle coupler, an MTH hook & loop coupler, a dummy coupler or a 1/32nd Kadee coupler. For your convenience, the MTH Proto-Coupler™, the hook & loop couplers, and dummy couplers have been included with your locomotive. The Kadee type must be the 1/32nd size and can be purchased from a Kadee coupler retailer.

The proto-coupler, the operating knuckle coupler, and the hook and loop coupler designs attach to the locomotive trucks in the same manner as seen in Figure 1.

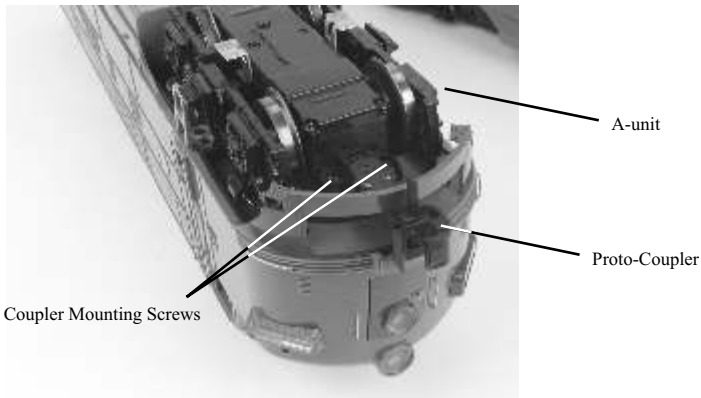

*Figure 1: Mounting Position For Proto-Coupler™ and Hook & Loop*

# Installing The Locomotive Couplers (cont'd)

If the locomotive is to be mated up with a different scaled G-Gauge locomotive, freight or passenger car, the height of the Proto-Coupler™ may need to be adjusted. The proto-Coupler comes installed in position “A” on the A-unit. To lower the Proto-Coupler to position “B” unscrew it and add the spacer seen in figure 2 under the coupler. Then use the longer screws provided to screw the Proto-Coupler back down. See Figure 3.



Figure 2: Spacer



Figure 3a: Coupler Position A



Figure 3b: Coupler Position B

Note: When the Proto-Coupler™ is installed in position B you will need to make a slight modification to the pilot. You will need to cut the entire pilot area under the coupler. For your convenience we have scored the back of the pilot. Also the coupler knuckle pin must be cut off as shown in Fig. 4. The coupler pin has also been “scored” so that it can be easily cut off with a pair of snippers.

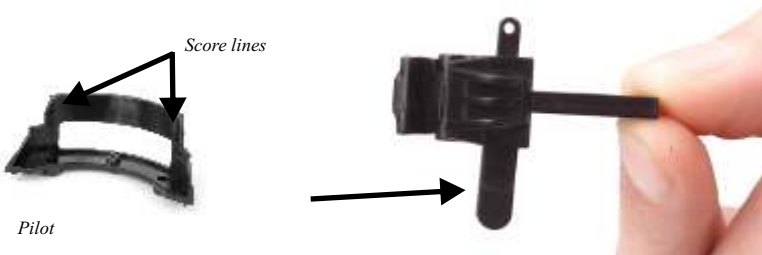

Figure 4: Score Line For Pilot and Knuckle Coupler Position

The Hook and Loop coupler mounts to the truck in the same manner as the Proto-Coupler™ (see Fig. 1 on page 3).

If a Kadee Coupler is to be installed, remove the MTH Proto-Coupler™ or hook & loop coupler & armature and install the separately purchased Kadee Coupler with the Spacer provided as seen in Figure 5. Follow the Kadee Coupler’s installation guide for complete details on installing the coupler.

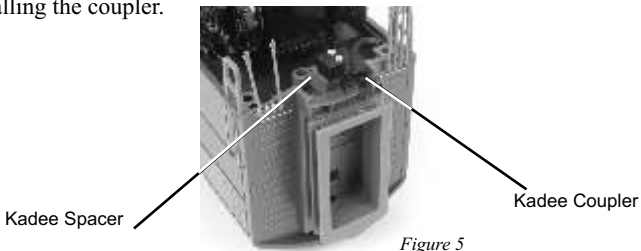

Figure 5

# Installing The Locomotive Couplers (cont'd)

To install a Kadee Coupler on the pilot, you must remove the existing coupler and then remove the pilot by unscrewing the two mounting screws as seen in Figure 6.

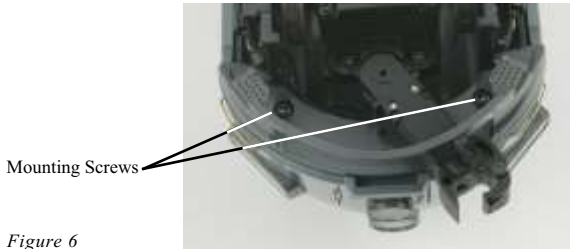

Figure 6

To install the separately purchased Kadee Coupler with the Spacer provided as seen in Figure 7. Follow the Kadee Coupler's installation guide for complete details on installing the coupler. Finally, screw the new coupler into the new spacer and reattach the pilot.



Figure 7: The Spacer

## Set Up for Running on R-2 & Larger Radius Curves

This locomotive comes equipped to run on R-1 Curve track. If you have purchased a non-powered A-Unit and are running your engine on larger radius track you may want to bring the A-Units closer together so that the diaphragms are touching. In order to bring the engines closer together you will first need to remove the rear mounted Proto-Coupler™. Then apply the dummy coupler as seen in Figure 8.

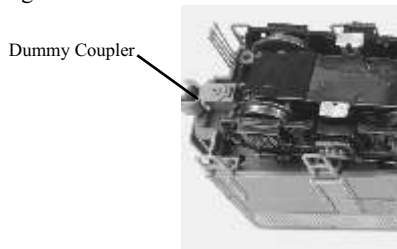

Figure 8

# Lubrication

You should lubricate the engine to prevent it from squeaking. Use light household oil and follow the lubrication points marked “L” in Fig. 9. Do not over-oil. Use only a drop or two on each pivot point.

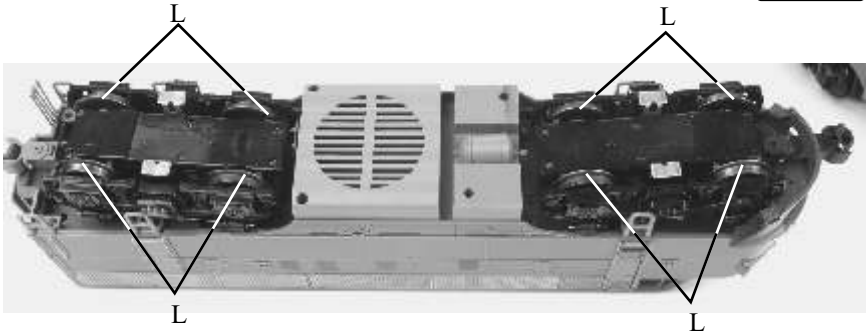

Figure 9. Lubrication Points on the Locomotive



**Running the engine without a primed smoke unit may cause damage**

## Priming The Smoke Unit

When preparing to run this engine, add 30-40 drops of smoke fluid through the smokestack. We recommend M.T.H. ProtoSmoke™ fluid. Do not overfill the unit or the fluid may leak out and coat the interior engine components.

If you choose not to add the fluid (or have already added the fluid but choose to run smoke-free), rotate the smoke unit knob located inside the side rear door (see Fig. 10) to the off position (rotate counterclockwise). If you wish to regulate the smoke output intensity, turn the knob between full counterclockwise and full clockwise until the desired smoke output is reached. **Failure either to add fluid to the unit or to turn it off may damage the smoke unit heating element and/or wicking material.**

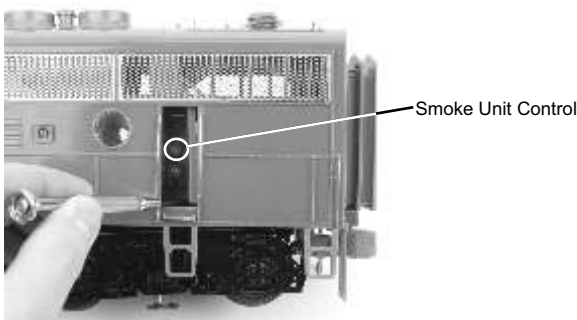

Figure 10: Smoke Unit Switch

# Filling The Smoke Unit

While MTH does not recommend operating outdoors in inclement weather (in order to prevent possible damage to the electronics), we have included for your convenience, a smoke stack “cap” inside your locomotive packaging. This cap should be inserted on the smoke stack to prevent moisture from entering the smoke unit chamber. (*Ensure that the smoke unit is turned off when the cap is in place.*)

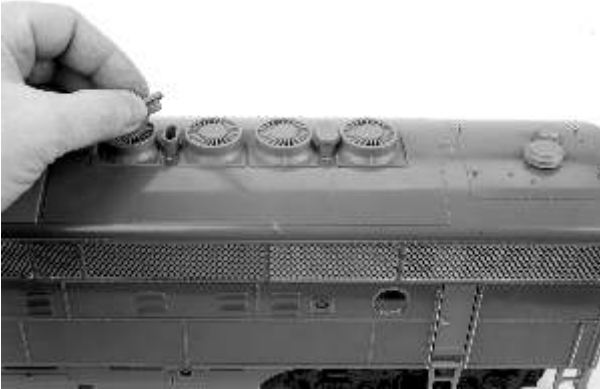
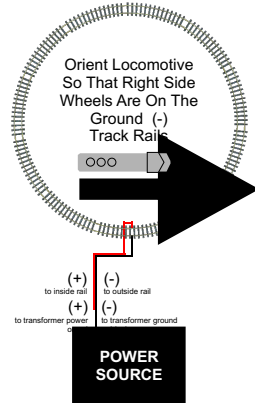

Figure 11: Smoke Unit Cap

# Placing The Engine On The Track

Like all DC powered locomotives, this engine is polarity sensitive. In general, the locomotive should be placed on the track with the cab facing toward the right if the outside rail is the (-) rail and the inside rail is the (+) rail.



# Checking The Battery

You may find, if your locomotive was built several months before you set it up, that the rechargeable batteries have run down and need to be charged before operating. If you notice that the sounds are garbled, test and charge the engine as described in the "Self-Charging Battery Back-Up" on page 22.

## Installing The Locomotive Pilot Detail Parts

Snap brake hose details to end of shell. (If you are going to run on R-1 Curve you may need to cut a few of the pipe details to prevent the engine from possibly derailing.)

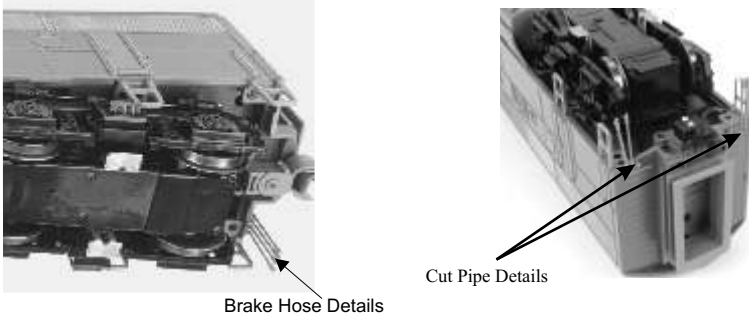

Figure 12: Attaching Brake Hose Details

## Connecting The Engines Together

If you have purchased a Non-Powered A-Unit you will need to remove the Proto-Coupler™ from the rear end of the Powered A-Unit and apply the dummy coupler in its place before connecting the engines.

Unscrew the Proto-Coupler™ and unplug the wire Connector.

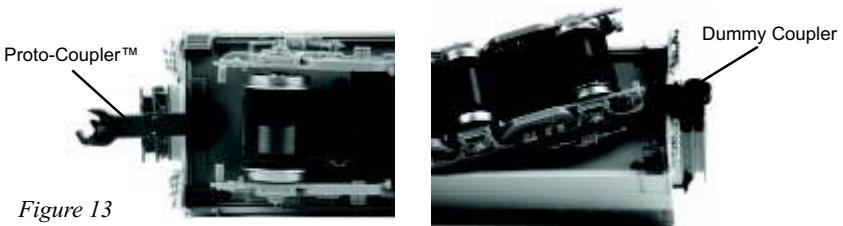

Figure 13

On the bottom of the engine there is a change-over switch. This will allow the Proto-Coupler to operate on the Trailing A-Unit. Flip the switch on the bottom of the engine.



Figure 14

Plug the cable into the end of both A-Units.



Figure 15



# Basic Operation

RailKing One-Gauge locomotives can be operated with AC or DC power output transformers. When using DC output power supplies, the user can only control the locomotive speed and direction. The locomotive will still make engine sounds but no bell or whistle control is possible when using a DC output power supply unless the user wishes to hook up the power supply to MTH's separately sold Digital Command System (see next page).

As with all G-Gauge locomotives, the Throttle knob or handle controls how fast your train will travel.

## Activating Features Using DC Power

**Throttle** - To increase or decrease track voltage, and therefore train speed, turn or slide the throttle control knob. Turning clockwise will increase voltage and speed, while turning counterclockwise will decrease voltage and speed. Because your RailKing One-Gauge locomotive is equipped with M.T.H.'s Proto-Speed Control feature, the engine will maintain the speed you set after you release the throttle until you turn it again to slow down or speed up the locomotive. This feature works very similarly to the cruise control system found in automobiles and allows the engine to maintain its speed even as it enters curves, traverses grades or coasts down inclines.

**Direction** - There are two ways to change a locomotive's direction when operating the engine with a DC power supply.

1. Slow the locomotive down using the throttle knob until the engine comes to a complete stop but power still remains on the track. Slide the direction switch on the power supply to the opposite direction and increase the throttle setting again to allow the locomotive to begin running in the opposite direction.
2. While the locomotive is running, slide the direction switch on the power supply to the opposite direction. The locomotive will slow to a gradual stop and then reverse direction and slowly gain speed until it is again travelling at its original speed prior to the direction switch change.

## Using DCS With DC Power

M.T.H.'s revolutionary Digital Command System, or DCS, allows users to control their RailKing One-Gauge locomotives in a command control environment. User's can remotely access hundreds of features inside each RailKing One-Gauge locomotive with the wireless remote control. Digital signaling and an easy-to-use interface make using DCS a snap. More information on DCS can be found on page 25 or by visiting [www.protosound2.com](http://www.protosound2.com).



# DCS / POLARITY Switch

Your model is equipped with a DCS / POLARITY switch that is used to properly orient the polarity of the power and the DCS signal going to the circuit board.

The DCS / Polarity Switch is located underneath the engine, between the truck and fuel tank. (See Figure 16)

There are 2 situations that may require the operator to change the position the DCS / Polarity Switch.

## DC Mode

In DC operation the polarity of the voltage applied to the track rails determines the direction of travel for the engine. If the MTH engine is facing the same direction as other engine(s), but it runs in the opposite direction of the other engine(s) when the power is applied to the track, you will need to select the other position of the DCS Polarity Switch. This will change the direction of travel for the MTH RailKing Gauge-One Engine and will have the MTH engine operating in the same direction as the other engine(s).

## DCS Mode

In the DCS mode (using AC or DC). The control electronics is expecting the DCS signal on the high or + side of the transformer / power pack output. If the engine is placed on the track facing the wrong direction, the engine will not receive the DCS Signal and will not be recognized by the Track interface unit (TIU). If the engine is not recognized by the TIU, or if the engine sounds start up when the power is applied to the track with a TIU connected, the DCS / Polarity Switch will need to be moved to the other position.

The DCS / Polarity Switch is oriented so that the switch is moved toward the rail with High / + / Red output terminal from the Transformer / Powerpack / TIU.

If your engine starts out in the direction you want or if the TIU recognizes the engine there is no need to change the setting of the DCS / Polarity Switch.

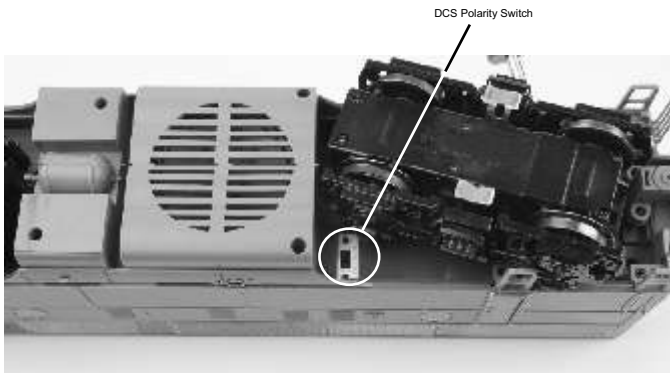

Figure 16

# Activating Features Using AC Power

Using an AC output transformer equipped with a whistle and bell button will unlock dozens of features inside your RailKing One-Gauge locomotive. Operation is simple by following the simple steps below and on the following pages.

**Start Up** - Turn the throttle knob up ½-way, until the engine headlight shines bright.

Put the engine into motion by pressing the Direction button on your transformer once. (hold it for approximately 1 second)

If the engine does not begin to move as soon as you firmly press the Direction button, you may not have sent enough voltage to the track to make the train move. Turn the throttle up a bit higher until the train begins to move.

**Throttle** - To increase or decrease track voltage, and therefore train speed, turn the throttle control knob. Turning clockwise will increase voltage and speed, while turning counterclockwise will decrease voltage and speed. The engine will maintain the speed you set after you release the throttle until you turn it again to change the voltage and speed.

**Bell** - To sound the bell, in an engine equipped with a bell firmly press and release the Bell button. To turn the bell off, press and release the Bell button again. The bell will continue to ring from the time you turn it on until you press and release the button again to turn it off.

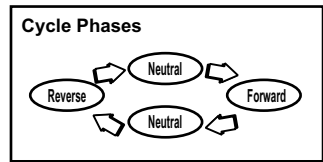

**Horn/Whistle** - To sound the whistle, firmly press the Horn/Whistle button. The whistle will sound for as long as you continue to depress the button. It will stop when you release the button.

**Direction** - Your train is programmed to start in neutral. The train will always cycle neutral-forward-neutral-reverse with each press and release of the direction button. The engine is programmed to restart in neutral each time the track voltage is turned off for 25 seconds or more.

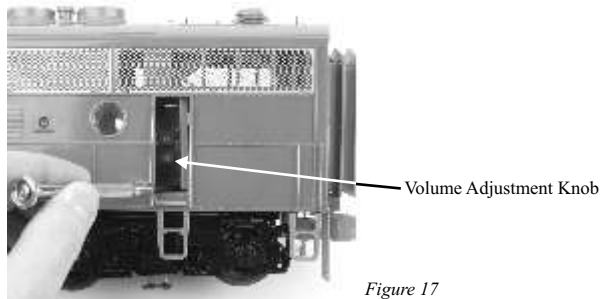

Figure 17

**Manual Volume Adjustment** - To adjust the volume of all sounds made by this engine, turn the master volume control knob located inside the door on the side rear of the cab clockwise to increase the volume and counter-clockwise to decrease the volume.

# Proto-Sound® 2.0 Operating Instructions

The following pages contain the operating instructions for Proto-Sound 2.0 RailKing One-Gauge locomotives when operated with AC output transformers in conventional mode only. Instructions for accessing DCS command mode features accompany the DCS Remote Control System equipment. These features are only available when using an AC Transformer equipped with a whistle and bell button.

## Activating Proto-Sound® 2.0 Conventional Mode Features (AC Operation Only)

Proto-Sound 2.0 features are activated by sequences of Bell and Horn button pushes described below. Please read the full descriptions of each feature before using it. To use these buttons to activate features rather than to blow the horn or ring the bell, you should tap the buttons very quickly with a ½-second pause between button presses. You may need to practice your timing to make this work smoothly.

Timing Chart				
Press Horn Short & Firm	½ Sec. Pause	Press Bell Short & Firm	½ Sec. Pause	Press Bell Short & Firm
Total Time Lapse: 1 ½ Seconds				

Feature to Be Activated:	Button Code:
Freight Yard Sounds	1 Bell, 2 Whistle/Horn
Fire the Rear Coupler	1 Bell, 3 Whistle/Horn
Fire the Front Coupler	1 Bell, 4 Whistle/Horn
Speed Control On/Off	1 Whistle/Horn, 2 Bells (From Neutral Only)
Lock into a Direction/Unlock	1 Whistle/Horn, 3 Bells
Reset to Factory Defaults	1 Whistle/Horn, 5 Bells (From Neutral Only)

## Freight Yard Sounds (FYS) or Passenger Station Announcements (PSA):

Your engine is equipped with a sound package of either freight yard or passenger station sounds that you can play. **Each sequence described below will play as long as it is left on, randomly generating sounds, but be sure to allow approximately 30 seconds between the button pushes described below to allow the FYS/PSA sufficient time to run through each sequence.**

- To cue the sound system to play the FYS/PSA, quickly but firmly tap the Bell button once followed by 2 quick taps of the Horn/Whistle button while the engine is moving. Tap the buttons quickly but allow approximately ½ second between each press.
- Press the Direction button once to stop the engine. This will trigger the first sequence of FYS/PSA. The reverse unit is temporarily disabled so that the train will not move as you use the Direction button to trigger the sounds, and Proto-Sound 2.0 has disabled operator control over the Horn/Whistle and Bell buttons until the full FYS/PSA sequence is complete.
- After waiting about 30 seconds for that sequence to run, press the Direction button again to trigger the second sequence of FYS/PSA.
- After about 30 seconds, press the Direction button again to trigger the third FYS/PSA sequence.
- Again, after allowing about 30 seconds for that sequence to run, press the Direction
- FYS/PSA will continue, and within a few seconds, the engine will start and move out on its own at the current throttle setting, in the same direction it was traveling when you began the sequence. Once the bell turns off, the operator regains control of the transformer's Bell and Horn/Whistle buttons and can ring the bell or blow the horn/whistle as usual.

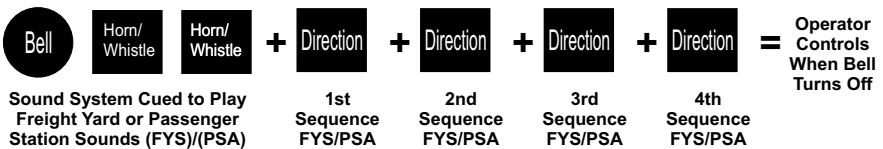

## Tips on Using FYS/PSA

- You can terminate FYS/PSA at any time by turning off power to the track for 15 seconds.
- You do not have to be in Forward to use FYS/PSA. At the conclusion of the full sequence, the train will pull away from the station in whatever direction you were going when you activated the feature.
- You can use FYS/PSA even if you are double-heading with another engine. If the second engine is not equipped with Proto-Sound 2.0, you must remember not to leave the throttle at a high voltage level once you have stopped the engine to run the FYS/PSA. Otherwise, the engine without FYS/PSA will begin vibrating on the track as its motors strain to move the train, since they cannot be automatically disabled during the FYS/PSA cycle (or if an original Proto-Sound engine, FYS/PSA are triggered differently and that engine's motor-disable feature will not be active when you run FYS/PSA in Proto-Sound 2.0).
- FYS/PSA can be triggered from Neutral. It will operate the same as if triggered while in motion except that, at the conclusion of the FYS/PSA, the engine will depart in the next direction of travel, as opposed to the direction it was traveling before entering Neutral.

## Proto-Coupler™ Operation

This locomotive is equipped with one or more coil-wound Proto-Couplers for remote uncoupling action. Because Proto-Couplers are controlled through the Proto-Sound 2.0 microprocessor, they do not require an uncoupling track section or modification to your layout to function. You can fire a coupler from neutral or while in motion. Use the code shown below (and in the chart on p. 14) to fire the coupler(s).

### Rear Coupler:

To fire the rear coupler, quickly tap the Bell button once followed by three quick taps of the Horn button, allowing approximately ½ second to lapse between each quick button press. The sound of the liftbar and air line depletion will play, and the knuckle will be released.



### Front Coupler:

To fire the front coupler (if your engine has one), quickly tap the Bell button once followed by four quick taps of the Horn button, allowing approximately ½ second to lapse between each quick button press. The sound of the liftbar and air line depletion will play, and the knuckle will be released.



## Speed Control

M.T.H. engines equipped with Proto-Sound 2.0 are equipped with Proto-Speed Control which allows the locomotive to maintain a constant speed up and down grades and around curves, much like an automobile cruise control. You can add or drop cars on the run, and the engine will maintain the speed you set.

While the engine is programmed to start with the speed control feature activated, you can opt to turn it off. This means the engine's speed will fall as it labors up a hill and increase as it travels downward. It is also affected by the addition or releasing of cars while on the run. Because the engine will run more slowly at a given throttle voltage when speed control is on than when it is off, you should adjust the throttle to a lower power level for operation with speed control off to avoid high-speed derailments. When speed control is off, the sound volume will drop to allow for better low voltage operation.

### To turn speed control on and off:

Place the locomotive in neutral, then quickly tap the transformer's Horn button one time then quickly tap the Bell button two times, allowing approximately ½ second to lapse between each quick button press. Two horn blasts will indicate that the engine has made the change. Repeat the 1 horn, 2 bells code to return it to the other condition. You will want to do this during the initial neutral upon start-up if you ever couple this engine to another engine that is not equipped with speed control to avoid damaging the motors in either engine. Each time you shut down the engine completely, it will automatically turn speed control on.





# Locking Locomotive Into A Direction

You can lock your locomotive into a direction (forward, neutral, or reverse) so that it will not change directions. To do this, put the engine into the direction you want (or into neutral to lock it into neutral), run it at a very slow crawl (as slowly as it will move without halting), and quickly but firmly tap the Horn button once followed by three quick taps of the Bell button, allowing approximately ½ second to lapse between each quick button press. Two horn blasts will indicate that the engine has made the change. The engine will not change direction (including going into neutral) until you repeat the 1 horn, 3 bells code to return the engine to its normal condition, even if the engine is kept without power for extended periods of time.



# Reset To Factory Default

To override the settings you currently have assigned to the locomotive and reset it to its factory defaults, while in Neutral tap the Horn button quickly once, followed by five quick taps of the Bell button, allowing approximately ½ second to lapse between each quick button press. Two horn blasts will indicate that the engine has made the change.



# Automatic Sound Effects

Certain Proto-Sound 2.0 sound effects automatically play in programmed conventional mode conditions:

- Squealing Brakes play any time the engine's speed decreases rapidly.
- Cab Chatter plays at random intervals when the engine idles in neutral.

Engine Start-up and Shut-down sounds play when the engine is initially powered on or is powered off for five seconds or more.

# Maintenance

## Lubricating and Greasing Instructions

The engine should be well oiled and greased in order to run properly. You should regularly lubricate all locomotive axles to prevent them from squeaking and enhance operation. Use light household oil and follow the lubrication points marked “L” in Fig. 18. Do not over-oil. Use only a drop or two on each pivot point.

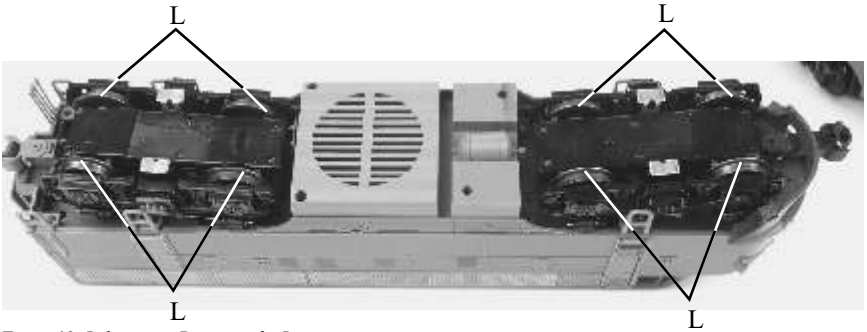

Figure 18: Lubrication Points on the Locomotive

The locomotive’s internal gearing was greased at the factory and should not need additional grease until after 50 hours of operation or one year, whichever comes first. To access the gear box and axles, do the following:

1. Turn the engine upside down and remove the truck bottom plate mounting screws as seen in Figure 19.

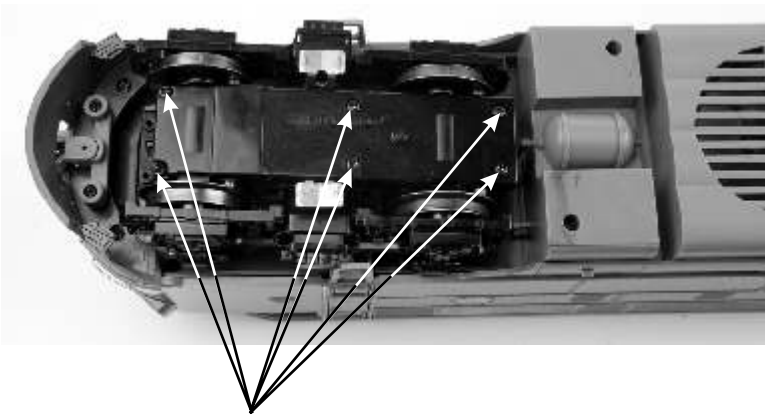

Figure 19 Truck Bottom Plate Mounting Screws

2. After removing the truck bottom plate, liberally apply grease to the gears attached to both the outside axles as seen in Figure 20.

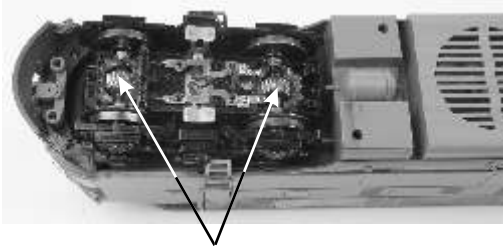

Figure 20: Grease Points Inside Power Truck

## Traction Tire Replacement Instructions

Your locomotive is equipped with two neoprene rubber traction tires on the rear set of flanged drivers on each truck. While these tires are extremely durable, you may need to replace them at some point.

1. Remove the truck sides from the truck block in order to slip the new tire over the grooved drive wheel. Each truck side is attached to the truck block via (2) screws as noted in Figure 21.

2. Make sure the old tire has been completely removed from the groove in the drive wheel, using a razor blade or small flathead screwdriver to pry away any remains.

3. Slip the new tire onto the wheel. You may find it useful to use two small flathead screwdrivers to stretch the tire over the wheel.

4. If you twist the tire while stretching it over the wheel, you will need to remove and reinstall the tire. Otherwise your engine will wobble while operating.

5. Make sure the tire is fully seated inside the groove. Use a razor blade to trim away any excess tire that doesn't seat itself inside the groove properly.

6. Reinstall the truck sides and operate as usual.

One set of replacement tires is packaged with your model. Additional sets are available directly from the M.T.H. Parts Department (order online: [www.mth-railking.com](http://www.mth-railking.com), e-mail: [parts@mth-railking.com](mailto:parts@mth-railking.com); mail: 7020 Columbia Gateway Drive, Columbia MD 21046-1532, FAX: 410-381-6122).

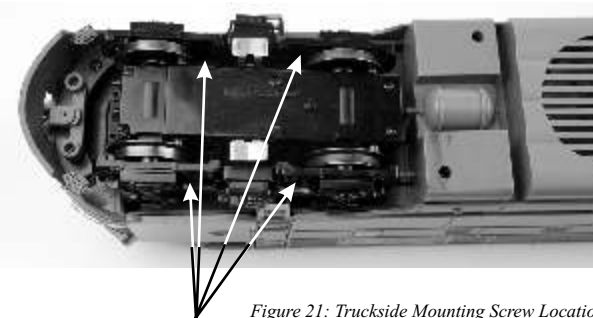

Figure 21: Truckside Mounting Screw Locations

# Light Bulb Replacement Instructions

The locomotive lights are controlled by a constant voltage circuit in the engine. They can be removed and replaced when they burn out by separating the body from the chassis as seen on the following pages. Once the body has been separated, see the illustrations below to remove the lights.

You can obtain replacement bulbs directly from the M.T.H. Parts Department (order online: [www.mth-railking.com](http://www.mth-railking.com), e-mail: [parts@mth-railking.com](mailto:parts@mth-railking.com); mail: 7020 Columbia Gateway Drive, Columbia MD 21046-1532, FAX: 410-381-6122).

## To Remove The Body From The Chassis

- 1) Locate and remove the 6 body mounting screws as seen in Figure 22.

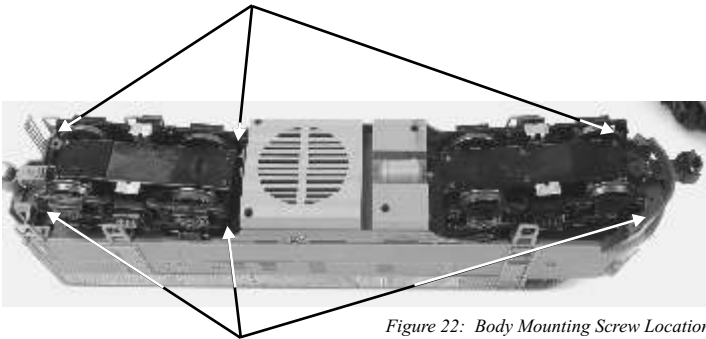

Figure 22: Body Mounting Screw Locations



Figure 23: Wire harnesses connect lights inside the locomotive body.

- 2) Gently lift the body from the chassis to expose the light and smoke unit harnesses. There are wire harnesses that connect lights inside the locomotive body that must be removed before the body can be completely separated from the chassis as seen in Figure 23.

# Light Bulb Replacement Instructions Cont'd

## Lights

1. To replace the number board lights you will need to remove the brackets. Then pull the lights out of the guides.

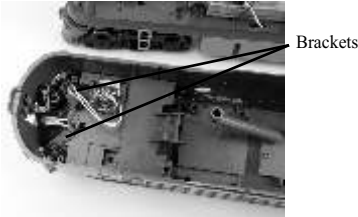

Figure 24: Removing the brackets.



Figure 25: Pulling the lights out of the guides.

2. To replace the mars light (if applicable) you will need to remove the holder on the door. See figure 26.

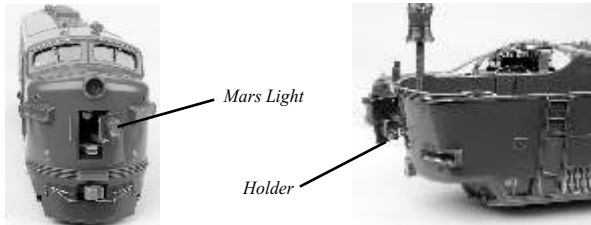

Figure 26

3. To replace the interior lights you will need to remove the interior. You will first need to remove the number boards light brackets. Then remove the screws that hold the interior. You may also need to remove some of the 2-pin connectors from the PCB.

### To Replace:

Gently pull the wires until the bulb comes free of the housing. Push the new bulb into place and reconnect the wires.

## Self Charging Battery Back-up

The special rechargeable 2.4v self-charging battery recharges continuously during train operation and should last for up to five years. The battery is a dry battery that should not leak or cause any damage to your engine. Depending upon when your engine was built, it may need to be charged right out of the box. If engine sounds seem distorted or garbled at low voltages or become silent when power from the transformer is turned off, test the battery to determine whether it should be recharged or replaced.

**Test:** Put the engine in neutral and leave the track voltage at 10-12 volts (high enough for the lights to shine brightly) for 15 minutes.

**Recharge:** If the sounds are improved at the end of the 15-minute test charge, the battery charge has run down and can be recharged. There are a number of ways you can do this:

- Leave the engine in neutral with track voltage at 10-12 volts for 6-7 hours so the battery can fully recharge (if your engine has a smoke unit, be sure it is turned off).
- Use M.T.H.'s battery recharger (Item No. 50-1019) (sold separately) that plugs into a wall outlet and a special port under the engine to recharge the battery overnight without leaving it on the track.

**Replace:** If the sounds are not improved at the end of the 15-minute test charge, it is time to replace the battery. Available through M.T.H. Parts:  
(Item No. 50-1024) AA NiCad Proto-Sound® Battery (Blue Casing)  
(Item No. BG4000004) AAA NiMH Proto-Sound® Battery (Green Casing)

DO NOT substitute alkaline batteries for these rechargeable batteries. Using alkaline batteries in this system can result in damage to the PS 2.0 circuit board and/or the batteries.

\*\*Do not use alkaline batteries for testing or checking purposes for the 3-Volt PS2 boards. Using alkaline batteries will damage the 3-Volt battery charging circuit.\*\*



Figure 28: Battery Recharging Port

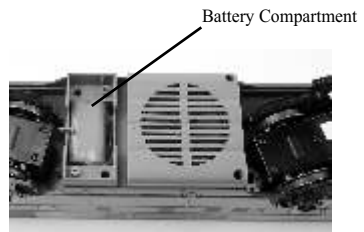

Figure 27: Battery Compartment

# ProtoSmoke™ Unit Operation

This RailKing One-Gauge diesel locomotive contains a self-powered smoke unit that outputs smoke through the smokestack on the roof of the engine. The smoke unit is essentially a small heating element and wick that soaks up and then heats a mineral oil-based fluid that emits a harmless smoke. The smoke is then forced out of the stack by a small electric fan. Smoke volume is controlled by the Proto-Sound 2.0 system.

With a few easy maintenance steps, you should enjoy trouble-free smoke unit operation for years.

When preparing to run this engine, add 30-40 drops of smoke fluid through the smokestack (see Fig. 29). We recommend M.T.H. ProtoSmoke™ fluid. Do not overfill the unit or the fluid may leak out and coat the interior engine components.

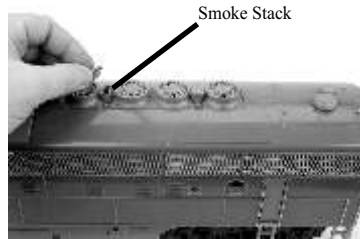

Figure 29

If you choose not to add the fluid (or have already added the fluid but choose to run smoke-free), turn off the smoke unit switch located inside the rear right side door (see Fig. 30). Failure either to add fluid to the unit or to turn it off may damage the smoke unit heating element and/or wick material.

When the smoke output while running the engine begins to diminish, add another 10-15 drops of smoke fluid or turn the smoke unit off.

When storing the unit for long periods of time, you may want to add about 15 drops of fluid to prevent the wick from drying out.

After removing the engine from storage, add another 25 drops of fluid, letting the wick soak up the fluid for 15 minutes prior to operation.

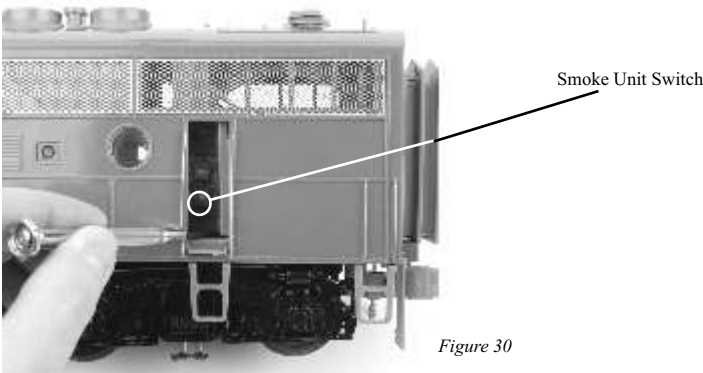

Figure 30

# ProtoSmoke™ Unit Maintenance

If you experience poor or no smoke output when the smoke unit is on and has fluid, check the wick to see if it has become hard, blackened, and unabsorbent around the heating element. To inspect the smoke unit you will need to remove the body from the chassis in order to gain access to the unit. Follow the body removal instructions found earlier in this manual.

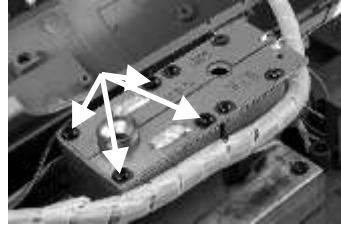

Figure 31

Once the body has been removed, you can remove the smoke unit circuit board from the smoke unit fluid reservoir by removing the four screws as seen in Figure 31. Inspect the wick; if it is darkly discolored and hard, it should be replaced.

Replacement parts and wick replacement instructions are available directly from the M.T.H. Parts Department (order online: [www.mth-railking.com](http://www.mth-railking.com), e-mail: [parts@mth-railking.com](mailto:parts@mth-railking.com); mail: 7020 Columbia Gateway Drive, Columbia MD 21046-1532, FAX: 410-381-6122).

## ProtoSmoke™ Fluid

ProtoSmoke is the recommended fluid for M.T.H. products and can be used in other manufacturers products as well. Choose from 12 different scents: Christmas, Coal, Diesel, Wood Burning, Coffee, Eggs & Bacon, Vanilla, Candy Cane, Barbeque, Pipe Smoke, Cinnamon Roll, and Apple Pie



## Installing The Locomotive Pilot

If desired, your leading A-Unit can be outfitted with a scale pilot for more prototypical look. For your convenience we have provided an extra pilot w/ your A-Unit.



Scale Pilot

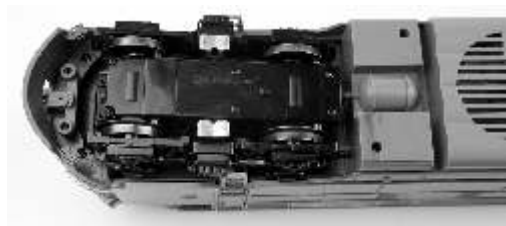

Figure 32



# Troubleshooting Proto-Sound®2.0 Problems

Although Proto-Sound 2.0 has been designed and engineered for ease of use, you may have some questions during initial operation. The following table should answer most questions. If your problem cannot be resolved with this table, contact M.T.H. for assistance (telephone: 410-381-2580; fax: 410-423-0009; service@mth-railking.com, 7020 Columbia Gateway Drive, Columbia MD 21046-1532).

<b>Starting Up</b>	<b>Remedy</b>
When I first turn the power on, the engine will not begin to run. I have to turn the throttle off and then on again to get the engine to operate.	This is normal behavior. To prevent accidental high-speed start-ups, Proto-Sound 2.0 is programmed to start up in neutral anytime track power has been turned off for several seconds.
<b>Whistle/Horn</b>	<b>Remedy</b>
When I press the whistle/horn button, the bell comes on instead.	Reverse the transformer leads.
I can't get the horn to blow when I press the whistle button.	You may be pressing the button too quickly. Try pressing the whistle/horn button more slowly, taking approximately one full second to fully depress the button.
<b>Bell</b>	<b>Remedy</b>
When I press the whistle button, the bell sounds.	Reverse the transformer leads.
I can't get the bell to ring when I press the bell button.	You may be pressing the button too quickly. Try pressing the bell button more slowly, taking approximately one full second to fully depress the button.
The bell won't work on a separate bell button.	Check the wiring of the separate button.

<b>Cab Chatter</b>	<b>Remedy</b>
Sometimes the Cab Chatter sounds don't play.	Cab Chatter plays only in neutral at random intervals.
<b>Lock-out</b>	<b>Remedy</b>
I can't get the engine to run after I power up the transformer. It sits still with the engine sounds running.	The engine is locked into the neutral position. Follow the procedure in the "Lock into a Direction" section.
The engine won't lock into forward, neutral, or reverse.	Engine speed must be below 10 scale mph (approx. 10 volts or less in conventional mode).
<b>Volume</b>	<b>Remedy</b>
The sounds seem distorted, especially when the whistle or bell is activated.	Proto-Sound 2.0 volume is set too high. Turn the volume control knob on the bottom of the chassis counter-clockwise to reduce the volume.
<b>Battery</b>	<b>Remedy</b>
The engine will not leave the initial neutral setting.	Check to be sure the battery is installed and fully charged. See the "Self-Charging Battery Back-Up" section.
I get no sounds when the engine shifts between directions.	The battery may be dead or need to be charged. See the "Self-Charging Battery Back-Up" section.
After I turn off my transformer, my engine continues to make sounds before quitting.	Proto-Sound 2.0 is designed to continue to sound for a few seconds after power to the track has been shut off.
<b>FYS</b>	<b>Remedy</b>
The FYS sounds occasionally repeat themselves.	Proto-Sound 2.0 has a built-in random number generator that randomly selects each sound clip to play. Because there are a limited number of sound clips available in each FYS sequence, it is probable that some of these sound clips will be repeated from time to time.

FYS	Remedy
Once in FYS, the engine doesn't go into reverse.	So that FYS effects can be as realistic as possible, Proto-Sound 2.0 disables the reversing unit whenever FYS is enabled. This way the engine remains still at its stop as the operator cycles through the FYS sequences.
When the FYS enters its last sequence the bell automatically comes on.	FYS is programmed to start ringing the bell at that point. After approximately 12 seconds it will automatically turn off.
When FYS is enabled, pressing the whistle and bell buttons has no effect.	Because FYS must control various effects in each sequence, Proto-Sound 2.0 takes control of these sound effects until you exit FYS.
I push the direction button but the next sound clip in the sequence does not play or the engine does not come out of FYS after fourth press of the direction button.	Each FYS clip must play for approx. 30 seconds before FYS will advance to the next step in the FYS cycle. Wait at least 30 seconds in each FYS sound clip before pressing the direction button.

## Recommended DC Power Supplies

Proto-Sound 2.0 is designed to work with most standard DC power supplies and AC transformers. The following charts lists the recommended DC and AC transformers. Note that many of the AC operational commands described in these instructions require a bell button, so if your AC transformer does not have its own bell button, you should consider adding one to get the full benefit of the system. In addition, the chart details how the terminals on these transformers should be attached to your layout. DC transformers employing PWM (pulse width modulation) should not be used with the separately sold DCS system.

<b>Transformer Model</b>	<b>Min/Max. Voltage</b>	<b>Power Rating</b>	<b>Transformer Type</b>
<b>MRC Controlmaster 20</b>	<b>0-20v</b>	<b>100 Watt</b>	<b>Electronic</b>
<b>PH Hobbies PS5</b>	<b>0-20v</b>	<b>100 Watt</b>	<b>Electronic</b>
<b>PH Hobbies PS10G</b>	<b>0-20v</b>	<b>180 Watt</b>	<b>Electronic</b>
<b>BridgeWorks Magnum-15</b>	<b>0-24v*</b>	<b>300 Watt</b>	<b>Electronic</b>
<b>BridgeWorks Magnum 200</b>	<b>0-24v*</b>	<b>300 Watt</b>	<b>Electronic</b>
<b>BridgeWorks Magnum 400</b>	<b>0-24v*</b>	<b>300 Watt</b>	<b>Electronic</b>
<b>BridgeWorks Magnum 1000</b>	<b>0-24v*</b>	<b>300 Watt</b>	<b>Electronic</b>
<b>LGB Jumbo 50101</b>	<b>0-24v*</b>	<b>240 Watt</b>	<b>Electronic</b>

\*Use 22 volts maximum track voltage when operating a MTH Locomotive equipped with Proto-Sound, Loco-Sound, or Proto-Sound 2.0

# Transformer Compatibility and Wiring Chart

Proto-Sound 2.0 is designed to work with most standard AC transformers. The chart below lists the many compatible transformers. Note that many of the operational commands described in these instructions require a bell button, so if your transformer does not have its own bell button, you should consider adding one to get the full benefit of the system. In addition, the chart details how the terminals on these transformers should be attached to your layout.

<b>RECOMMENDED AC TRANSFORMERS</b>					
<b>Transformer Model</b>	<b>Center Rail</b>	<b>Outside Rail</b>	<b>Min/Max. Voltage</b>	<b>Power Rating</b>	<b>Transformer Type</b>
MTH Z-500	Red Terminal	Black Terminal	0-18v	50-Watt	Electronic
MTH Z-750	Red Terminal	Black Terminal	0-21v	75-Watt	Electronic
MTH Z-1000	Red Terminal	Black Terminal	0-21v	100-Watt	Electronic
MTH Z-4000	Red Terminal	Black Terminal	0-22v	390-Watt	Electronic
Lionel 1032	U	A	5-16v	90-Watt	Standard
Lionel 1032M	U	A	5-16v	90-Watt	Standard
Lionel 1033	U	A	5-16v	90-Watt	Standard
Lionel 1043	U	A	5-16v	90-Watt	Standard
Lionel 1043M	U	A	5-16v	90-Watt	Standard
Lionel 1044	U	A	5-16v	90-Watt	Standard
Lionel 1053	U	A	8-17v	60-Watt	Standard
Lionel 1063	U	A	8-17v	60-Watt	Standard
Lionel LW	A	U	8-18v	75-Watt	Standard
Powermaster	U	A	8-18v	135VA	Electronic
All-Trol	Left Terminal	Right Terminal	0-24v	300-Watt	Electronic
Dallee Hostler	Left Terminal	Right Terminal			Electronic
Lionel LW	A	U	8-18v	75-Watt	Standard
Lionel KW	A or B	U	6-20v	190-Watt	Standard
Lionel MW	Outside Track Terminal	Inside Track Terminal	5-16v	50V.A.	Electronic
Lionel RS-1	Red Terminal	Black Terminal	0-18v	50V.A.	Electronic
Lionel RW	U	A	9-19v	110-Watt	Standard
Lionel SW	U	A	Unknown	130-Watt	Standard
Lionel TW	U	A	8-18v	175-Watt	Standard
Lionel ZW	A,B,C or D	U	8-20v	275-Watt	Standard
Lionel Post-War Celebration Series ZW	A,B,C or D	Common	0-20v	135/190 Watt	Electronic

\* Conventional Mode Only

# **Additional Features Accessible With The DCS Remote Control System**

(Additional equipment required)

While conventional mode operation of a Proto-Sound 2.0 engine yields wonderfully realistic sound and several train control features, command mode operation allows the user to access a world of command functions never before available to G Gauge railroaders. With the addition of the DCS Remote Control System (including a DCS remote handheld and Track Interface Unit) users gain many advanced features, including:

- **DCS Proto-Speed Control** - Establishes desired locomotive speed in scale miles per hour increments via a thumbwheel control and allows operator to set maximum speed and acceleration/deceleration rates
- **ProtoSmoke® Variable Output Control** - Controls how much smoke each engine outputs and matches smoke to locomotive speed
- **Locomotive Lighting Control** - Controls locomotive headlights, marker and interior lights, beacon lights, ditch lights, and MARS lights
- **Emergency Stop**-Single button push stops all Proto-Sound 2.0 trains but does not turn off the power
- **One Touch Global Mute/UnMute**-Single button mutes or unmutes all DCS-controlled locomotives' user-defined actions, including sound, lights, and smoke
- **Proto-Dispatch Operation**-Public Address-like feature allows users to speak through locomotive speaker during operation
- **Proto-Cast**-Allows users to play audio recordings through locomotive speaker during operation
- **Proto-Doppler Sound Effects Set Up**-Users can configure locomotive for Doppler Operation, including setting distance points for Doppler start, repeat, and stop modes
- **Independent Volume Control of Engine Sounds, Bell, Horn & Whistle** for each Locomotive
- **Control up to 50 different DCS-Equipped Locomotives at one time with multiple TIUs**
- **Proto-Effects™ Set Up**-User can select individual
- **Proto-Effects™ operations** to be active or inactive, including cab chatter, train wreck sounds, coupler sounds, and wheel clickety-clack sounds
- **Direction Control Set Up**-User can set initial individual start-up direction (start in forward or reverse) for double-heading operations
- **Locomotive Consist Set-up**-User can determine locomotive values for consist make-ups, allowing multiple locomotives belonging to a consist to operate together

# Service & Warranty Information

## How to Get Service Under the Terms of the Limited One-Year Warranty

When you suspect an item is defective, please check the operator's manual for standard operation and troubleshooting techniques that may correct the problem. Additional information may be found on the M.T.H. Website. Should you still require service, follow the instructions below to obtain warranty service.

First, e-mail, write, call or fax a M.T.H. Authorized Service Center (ASC) in your area to obtain Repair Authorization. You can find the list of ASCs on the M.T.H. Website, [www.mth-railking.com](http://www.mth-railking.com). Authorized Service Centers are required to make warranty repairs on items sold *only* from that store; all other repairs may-- or may not be done at the store's own discretion. If you did not purchase the item directly from the ASC, you will need to select a National Authorized Service Center (NASC). These centers are compensated by M.T.H. to perform warranty service for any customer whose repair qualifies for warranty service. A list of NASC retailers can be located on the M.T.H. Website or by calling 410-381-2580. Should the warranty no longer apply, you may choose either an ASC or NASC retailer to service your M.T.H. Product. A reasonable service fee will be charged.

**CAUTION:** Make sure the product is packed in its original factory packaging including its foam and plastic wrapping material to prevent damage to the merchandise. There is no need to return the entire set if only one of the components is in need of repair *unless otherwise instructed by the Service Center*. **The shipment must be prepaid and we recommend that it be insured. A cover letter including your name, address, daytime phone number, e-mail address (if available), Return Authorization number (if required by the service center, a copy of your sales receipt and a full description of the problem must be included to facilitate the repairs. Please include the description regardless of whether you discussed the problem with a service technician when contacting the Service Center for your Return Authorization.**

Please make sure you have followed the instructions carefully before returning any merchandise for service. Authorized M.T.H. Service Centers are independently owned and operated and are not agents or representatives of M.T.H. Electric Trains. M.T.H. assumes no responsibility, financial or otherwise, for material left in their possession, or work done, by privately owned M.T.H. Authorized Service Centers. If you need assistance at any time email MTH Service at [service@mth-railking.com](mailto:service@mth-railking.com), or call 410 381-2580.

## Limited One-Year Warranty

All M.T.H. products purchased from an Authorized M.T.H. Retailer are covered by this warranty. See our Website [www.mthtrains.com](http://www.mthtrains.com) to identify an M.T.H. Retailer near you.

M.T.H. products are warranted for one year from the date of purchase against defects in material or workmanship, excluding wear items such as light bulbs, pick-up rollers, batteries, smoke unit wicks, and traction tires. We will repair, replace, or credit (at our option) the defective part without charge for the parts or labor, if the item is returned to an M.T.H. Authorized Service Center (ASC) or M.T.H. National Authorized Service Center (NASC) within one year of the original date of purchase. This warranty does not cover damages caused by improper care, handling, or use. Transportation costs incurred by the customer are not covered under this warranty.

Items sent for repair must be accompanied by a return authorization number, a description of the problem, and **a copy of the original sales receipt from an Authorized M.T.H. Train Merchant**, which gives the date of purchase. If you are sending this product to an Authorized Service Center, contact that Center for their return authorization.

This warranty gives you specific legal rights, and you may have other rights that vary from state to state. Specific questions regarding the warranty may be forwarded to M.T.H. Directly.

Service Department:  
M.T.H. Electric Trains  
7020 Columbia Gateway Drive  
.Columbia MD 21046-1532