



DOCKSIDER 0-4-0 STEAM ENGINE TRAIN SET OPERATING INSTRUCTIONS



Making the Most of Your Investment

Thank you for purchasing this RailKing® Ready-to-Run Steam Engine Train Set. We at MTH Electric Trains take pride in manufacturing quality products like your set, and we hope that you will enjoy it for a long time. To ensure the maximum durability and pleasure from your locomotive, rolling stock, track and transformer, please read all the way through the **Quick Start Basic Operating Instructions** you will find beginning on pages. Remember that a little attention to routine maintenance yields a maximum of trouble-free performance.

RAIL
KING

Table Of Contents

QUICK START - BASIC OPERATION	4
Setting Up The RealTrax® Track System	4
Preparing The Locomotive & Cars For Operation	6
Lubrication	6
Operating The Locomotive & Cars	7
Electronic Reverse Unit	7
Transformer Operation	8
Special Reverse Unit Options	9
TRAIN SET MAINTENANCE	11
Oil	11
Grease	12
Locomotive Lamp Replacement	12
Caboose Lamp Replacement	13
RealTrax® TRACK LAYOUT PLANS	15
TRANSFORMER COMPATIBILITY CHART	18
EXPLODED PARTS VIEW DIAGRAM	19
SAFETY & WARNING PRECAUTIONS	23
SERVICE AND WARRANTY INFORMATION	24
HOW TO GET SERVICE	24
LIMITED ONE YEAR WARRANTY	24

Compatibility

Our designers have sized the engine to operate on any traditional 0-27 or larger O Gauge track system, including RealTrax® using any standard AC transformer including the Z-500 transformer packaged in your set. (See page 19 for a complete list of compatible transformers as well as wiring instructions.) All RailKing® products are compatible with most other 3-rail locomotives, rolling stock, and accessories.

Equipment Options

Your ready-to-run set features a 0-4-0 steam locomotive equipped with an operating headlight, mechanical whistle, ProtoSmoke® operating smoke unit and a solid state electronic reverse unit. All are simple and fun to operate. In addition to the locomotive, your set should also include a circle of RealTrax® track (8 curved sections), a RealTrax® lighted lock-on and wire harness set (for connecting the track to the transformer) and a 50-watt Z-500 transformer and controller.

You'll find complete instructions for choosing and setting up options in the following pages. If you don't read through the entire manual before starting to operate your equipment, be sure to check the **Quick Start Basic Operating Instructions**, which will give you the basics of the operating system.

CAUTION - ELECTRICALLY OPERATED PRODUCT:

Not recommended for children under ten years of age without adult supervision. As with all electric products, precautions should be observed during handling and use to reduce the risk of electric shock.

Transformer Ratings:

Input: 120 VAC

60 HZ Only

Output: 18VAC, 3A 54VA

Quick Start Operating Instructions

Track and Power

Although MTH Electric Trains manufactures its own track and transformers, you can run your locomotive on any 0-27 or wider-radius O gauge track wired to draw power from any of the standard compatible AC transformers listed in the chart on page 19. Be sure your track is in good condition—clean and securely connected—to keep the locomotive running and to prevent derailments. If you intend to utilize the RealTrax® track sections included in the set, see the directions below.

Setting Up the RealTrax® Circle

Unlike other O Gauge track systems, each RealTrax® track section features a realistic built-in roadbed base, solid nickel-silver track rails and realistic railroad ties, all designed to give the owner an authentic looking track system. In addition, each RealTrax® track section employs the use of quick-connect connectors instead of track pins or railjoiners to assemble the track sections to one another. The quick



Figure 2: RealTrax® sections in properly connected position.

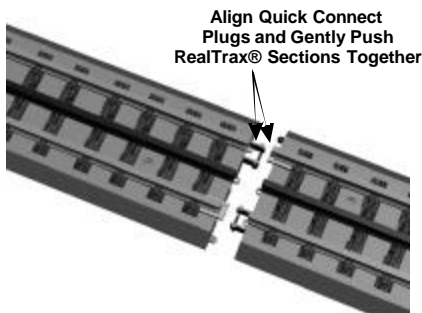

Figure 1: Preparing to snap RealTrax® sections together by aligning Quick Connect Connectors together.

connectors and built-in base allow RealTrax® track sections to be setup anywhere, including some carpeted surfaces without the need for track nails or the worry of carpet stains.

You can set up literally hundreds of different track designs utilizing RealTrax® components. We've included just a few later in this manual for your reference. Each

layout specifies the space required and the components needed to complete the track design. You can purchase additional track components from any authorized MTH retailer.

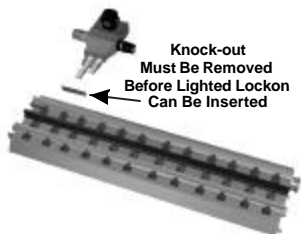

Figure 3: Top view position of lighted lockon preparing to enter RealTrax® section.

between the track and the transformer. Each RealTrax® track section includes two “knock-out” tabs in the roadbed (on either end

The lighted lockon included in your set snaps into any RealTrax® track section roadbed and functions as the interface

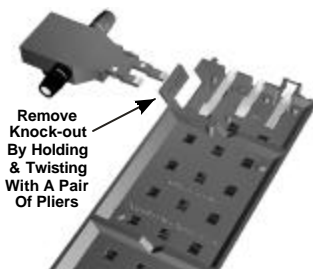

Figure 4: Underside view of RealTrax® section with “knock-out” removed and lighted lockon in position for insertion.

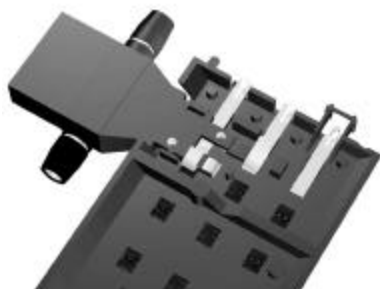

Figure 5: Underside view of RealTrax® track section with lighted lockon in fully seated position.



Figure 6: Top view of RealTrax® section with lighted lockon in fully seated position.

of the track) that can be removed to reveal an opening for the lighted lockon. To remove this *knock-out* grab the *knock-out* with a pair of pliers and gently twist the *knock-out* until it snaps away from the roadbed base. Once the *knock-out* has been removed, snap the lighted lockon into the roadbed taking care to make sure that the lockon arms snap into the roadbed electrical receptors. To complete the connection between the RealTrax® track section and the transformer, simply plug in the color-coded wire

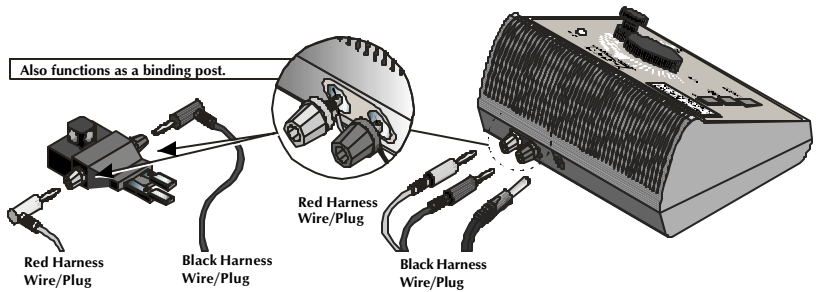

Figure 7: Wiring up the Z-500 transformer to the lighted lockon.

harness that was included in your set.

Preparing the Locomotive & Cars For Operation

Before you run your locomotive, you **must** oil the locomotive.

Lubrication

Before you run the locomotive, use a light household or hobby oil to lubricate the gears. Apply a small drop of oil (a pinpoint oiler will help place the right amount of oil where you need it) to each of the points indicated by figures 8 and 9. You may also want to use either a locomotive repair cradle or an old towel folded over to provide a protective bed for the locomotive shell while you're working on it.

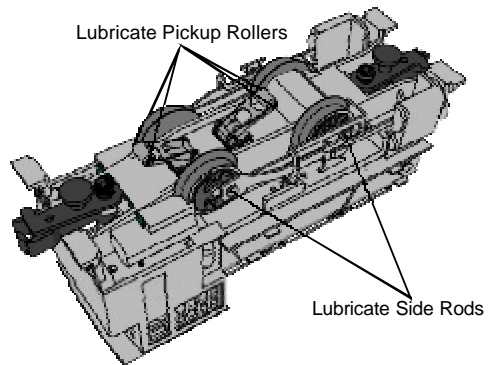

Figure 8: Lubrication points of RailKing 0-4-0 locomotive.

Because the locomotive's internal gearing has been greased at the factory, you shouldn't need to add more grease until you have run the locomotive for 50 hours or owned it for a year, whichever comes first. See the section on lubrication, pages 11-12, for details.

Adding Smoke Fluid

The 0-4-0 contains a self-powered smoke unit that outputs a steady stream of smoke through the smoke stack on the top of the engine. The ON/OFF switch must be in the ON position in order for the smoke unit to function. See Fig. 10 below.

The smoke unit is essentially a small heating element and wick which soak up and then "cook" a mineral oil-based fluid, that creates a harmless smoke. The smoke is then forced out of the stack via a small electric fan which runs at a constant speed. However, the smoke intensity can be varied by changing the transformer voltage setting. The higher the setting, the more intense the smoke output

Before operating the engine, you should add smoke fluid to the smoke unit by pouring 15 - 25 drops of fluid into the locomotive's smoke stack. Use the included ProtoSmoke® smoke fluid vial or Seuthe, LGB or LVTS smoke fluid before you run the engine. **If you don't choose to add the fluid, then the smoke unit switch should be turned off. Failure to either add the fluid or turn the switch off could lead to damage to the smoke unit heating element and or wicking.** After adding the fluid, gently blow into the stack to eliminate any air bubbles. Do not overfill the unit as overfilling can cause the fluid to leak out and coat the interior engine components. When the smoke output begins to diminish while running the engine, an additional 20-25 drops of smoke fluid should be added or the smoke unit switch should be turned off. When storing the engine for

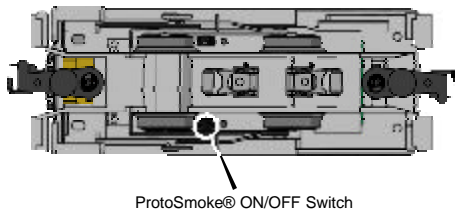

Figure 10: Locating the ProtoSmoke® ON/OFF Switch

long periods of time, you may want to add at least 15 drops of fluid to keep the wick soaked with fluid and prevent it from drying out. After removing the engine from storage, it is advisable to add another 25 drops of fluid, letting the wick soak up the fluid for 15 minutes prior to operation.

Operating The Engine and Cars

Once the track has been assembled, the transformer has been wired to the track lock-on, and the locomotive has been lubricated you are almost ready to begin running your new train set. Place the engine and cars on the track and couple them up to one another. If the coupler is already closed, pressing down on the coupler armature will open the coupler knuckle to allow the couplers to interlock with one another. The engine connects to the tender by a draw bar.

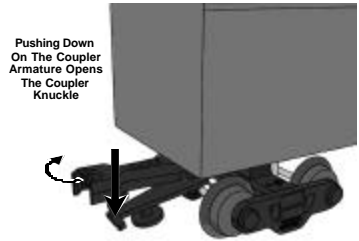

Figure 11: Pushing down on the coupler armature tab to open up the coupler knuckle.

Before turning on the transformer, it is important to understand the features of your new train set.

Electronic Reverse Unit

The 0-4-0 model is controlled by an electronic reverse unit. The reverse unit operates in the same manner that all reverse units function by using forward, neutral and reverse states that are entered each time the throttle is turned on and off, or by using the transformer direction button (if so equipped).

In addition to the electronic reverse unit, your new train set locomotive features a mechanical whistle that can be activated by pressing the white Horn/Whistle button on your Z-500 transformer. Any compatible transformer horn/whistle button will also activate the whistle in your new locomotive. Simply pressing the Horn/Whistle button whenever the throttle is above the OFF setting should activate the whistle. If the whistle doesn't blow, increase the throttle setting and press the button again. The whistle will blow as long as the button is depressed and voltage is applied to the track.

Transformer Operation

The Z-500 provides the model railroad enthusiast with an easy to use, safe power source for AC-powered trains and accessories. Operation is quick and easy by following the setup diagram below.

Button Functions:

Bell: Press to activate a digital sound system bell.

**Note: Pressing the bell button will have no effect on your set engine because your locomotive is not equipped with a bell. Only locomotives equipped with full digital sound systems*

(which feature engine sounds, horns, bells, air-release sound effects, squeaking brakes and many other locomotive related sound effects) can utilize the bell button.

Horn/Whistle: Press to activate the whistle

Direction: Press to stop motion of train and press again to change direction

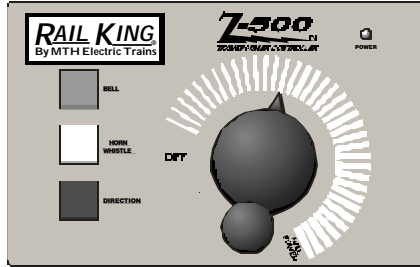

Figure 12: Z-500 Controls

Starting to Roll

Advance the transformer throttle. The locomotive's light will come on and the engine should now proceed in the forward direction. At this point, advancing the throttle further will allow the engine to pick up speed, reducing the throttle will slow the engine down. Turning the throttle OFF and then back ON will park the engine into neutral. Cycling the throttle OFF and then back ON again one more time will allow the locomotive to enter reverse.

Tip: An alternative method to using the throttle to enter the next reverse unit state is to press the direction button. When depressed, the transformer interrupts all power to the track. Releasing the button reapplies power to the track at whatever voltage level the transformer throttle is set at.

Special Reverse Unit Options

Locking Out The Reverse Unit Into A Single Direction

Your locomotive's electronic reverse unit may be locked out into one of three positions; forward, neutral or reverse. Locking the engine into one of these three positions prevents the locomotive from cycling through the reverse unit phases and is useful for operators employing block signal operations on their layout. Once locked into a position, turning the throttle OFF and then ON again will not allow the engine to enter the next reverse unit phase and instead keeps the engine in the current locked direction.

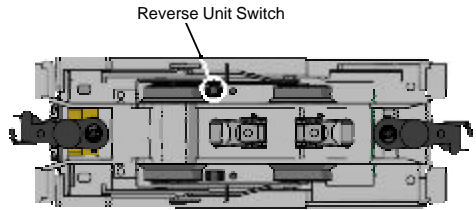

Figure 13: Electronic Reverse Unit Lock-out Switch location (bottom chassis view).

To lock the engine into one of the three positions, simply enter that position using the transformer throttle or direction button. Once in the desired direction, remove the locomotive from the track and slide the ON/OFF switch located on the bottom of the tender (See Figure 13) to the OFF position. This locks the engine into the desired direction. Sliding the switch back to the ON position resets the reverse unit into its normal cycling phases.

Train Set Maintenance Instructions

Proper locomotive performance requires regular attention to lubrication. The following guidelines should be followed to ensure that your set's locomotive lasts for many years of operation

Oil

Before operating the locomotive, apply a small drop of oil to lubricate the side rods and pick up rollers. Use light household oil and apply sparingly only to the points indicated by Figure 14. Wipe away any excess, especially if oil spills onto the finish of the locomotive. To prevent accidental scratches or other damage to the locomotive shell while you are working, you may want to place the locomotive in a repair cradle or an old towel or other cloth folded to provide a firm but soft resting place.

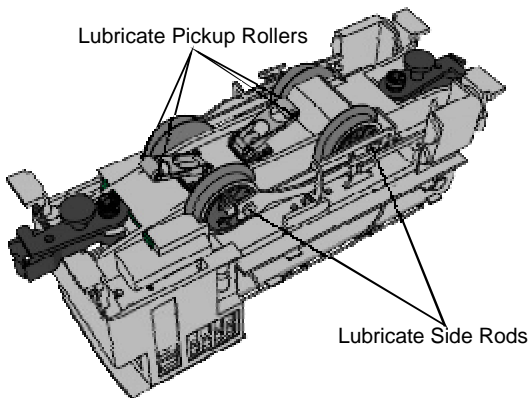

Figure 14: Lubrication points on RailKing® locomotive.

Check the locomotive oiling points periodically to be sure they are moving freely and quietly. If they are not, apply a small amount of oil again. Also check the locomotive wheels for dirt build-up that can cause performance problems. Such dirt build-up can interfere with electrical contacts, reduce traction (especially on elevated track sections), and cause neoprene traction tires to wear out prematurely.

Grease

Grease should be added to the internal drive gears annually or after every 50 hours of operation. Grease can be added by inserting grease into the gear box inside the locomotive chassis. In order to access the gear box, the boiler must be removed from the chassis by unscrewing the four chassis screws as seen in Figure 15 below. Once the boiler is removed, the smoke unit and the light bracket must also be removed, then the gear box can be opened up by unscrewing the three screws on the plate located in front of the motor. Grease can then be applied into the gear box using a grease tube dispenser.

Lamp Replacement

The lights in your locomotive or caboose car may occasionally burn out during normal operation. Should this occur, you will need to remove the boiler/caboose body from the chassis in order to replace the burned out bulb.

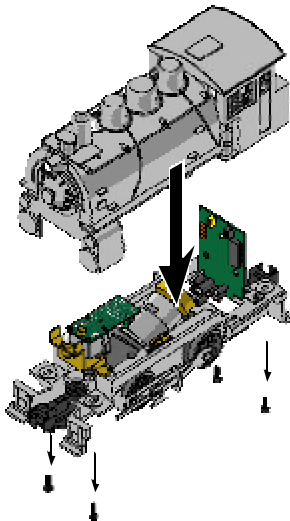

Figure 15: Removing the boiler to change the light bulb.

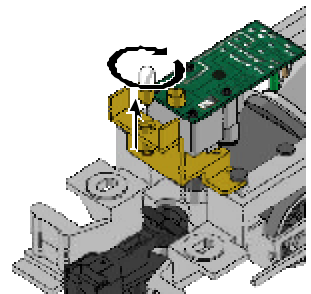

Figure 16: Locating and removing the light bulb.

To remove the 0-4-0 locomotive boiler from its chassis, follow the body removal instructions (see figure 15). Once the body has been removed, rotate the headlight bulb counter-clockwise as seen in Figure 16 to remove.

To remove the caboose car body from its chassis, turn the car over and locate and remove the four mounting screws (one in each corner of the car as seen in Figure 17) attaching the body to the chassis. Once the screws are removed, gently lift the car body up and away from the chassis.

After removing the body from the chassis, turn the chassis over and locate the car interior lamp housing mounted on the inside of the chassis. Remove the burned out bulb by pushing the bulb downward and rotating it counter-clockwise as seen in Figure 18. Once the bulb has been removed, install the replacement bulb by pushing down and turning the bulb clockwise to lock into place.

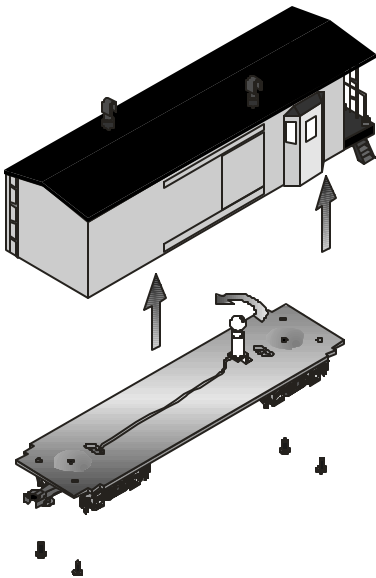

Figure 17: Removing the caboose body from its chassis..

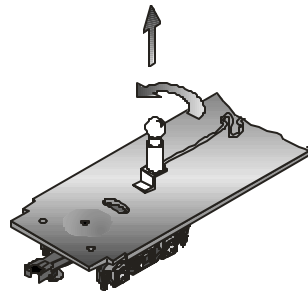

Figure 18: Locating and removing the interior bulb.

Locomotive Smoke Unit Maintenance

Operating the engine without smoke fluid and with the smoke unit switch in the ON position can damage your smoke unit wick, causing the wick to become hard, blackened and unabsorbent around the heating element. When this occurs, it may be difficult for the wick to soak up the smoke fluid resulting in poor or no smoke output. If that occurs, we recommend that you inspect and/or replace the wick taking care to not run the smoke unit without fluid in the future. You can inspect the wick to see if it needs replacement by removing the smoke unit inspection cover from the body as seen in Fig. 21. After removing the chassis and inspection cover screws lift the inspection plate away and inspect the wick. If the wick is darkly discolored and hard, it should be replaced. Replacement wick and detailed instructions are available directly from MTH Electric Trains.

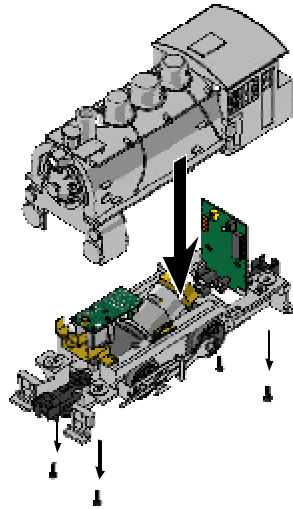

Figure 20: Removing the locomotive body for smoke unit maintenance.



Figure 21: Opening the smoke unit for wick replacement.

RealTrax® Layout Plans

The following are just some of the many different track plans you can utilize when designing your model railroad. Each track plan contains a table indicating which and how many track components you will need. Some track plans may require additional transformer power to accommodate the current draws of the various accessories featured in the layout, including switches and lights.

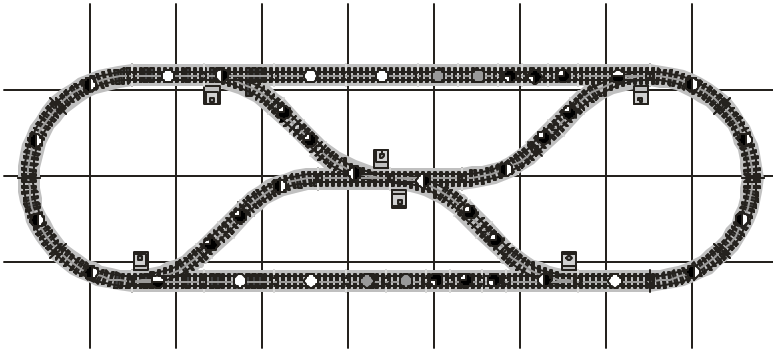

Track List:	Item #	Approximate Layout Size:
(6) 10" Straight	(40-1001)	102" x 32" (2.6m x 0.8m)
(10) O-31 Curved	(40-1002)	
(4) O-31 Right Hand Switch	(40-1004)	
(2) O-31 Left Hand Switch	(40-1005)	
(4) 5.5" Straight	(40-1012)	
(10) 4.25" Straight	(40-1017)	
(4) 3.5" Straight	(40-1018)	

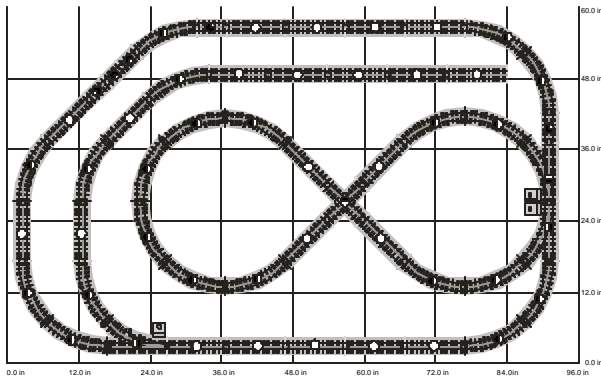

Track List:	Item #	Approximate Layout Size:
(22) 10" Straight	(40-1001)	96" x 60" (2.4m x 1.5m)
(21) O-31 Curved	(40-1002)	
(2) O-31 Right Hand Switch	(40-1004)	
(1) O-31 Left Hand Switch	(40-1005)	
(1) 90 Degree Crossing	(40-1006)	
(2) 5.0" Straight	(40-1018)	
(1) 4.25" Straight	(40-1017)	
(2) 3.5" Straight	(40-1018)	

inches.m
size: 8.00x 5.00
track sections: 52

RAILKING

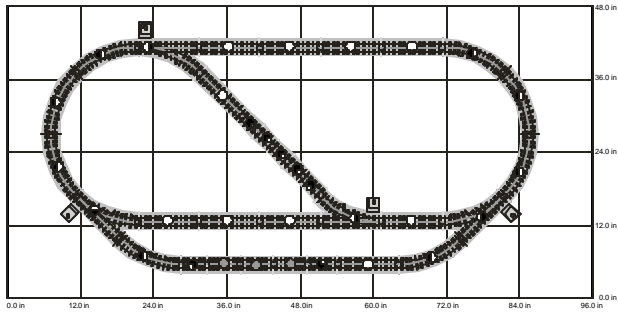

#trveo31.rst
size: 8.00 x 4.00
track sections: 32

Track List:	Item #
(10) 10" Straight	(40-1001)
(8) O-31 Curved	(40-1002)
(3) O-31 Right Hand Switch	(40-1004)
(1) O-31 Left Hand Switch	(40-1005)
(3) 5.5" Straight	(40-1012)
(1) 5.0" Straight	(40-1016)
(2) 4.25" Straight	(40-1017)
(4) 3.5" Straight	(40-1018)

Approximate Layout Size:
84" x 42" (2.1m x 1.1m)

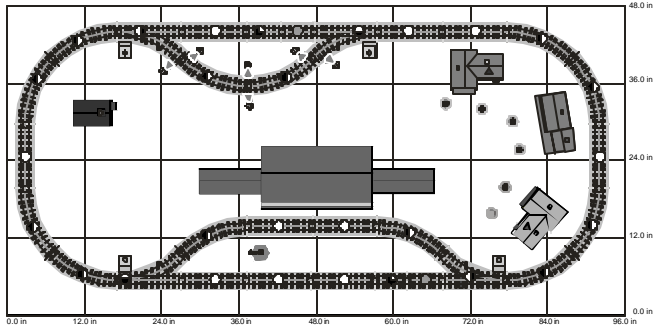

#trading5.rst
size: 8.00 x 4.00
track sections: 30

Track List:	Item #
(10) 10" Straight	(40-1001)
(12) O-31 Curved	(40-1002)
(2) O-31 Right Hand Switch	(40-1004)
(2) O-31 Left Hand Switch	(40-1005)
(2) 5.5" Straight	(40-1012)
(2) 5.0" Straight	(40-1016)

Approximate Layout Size:
92" x 42" (2.3m x 1.1m)

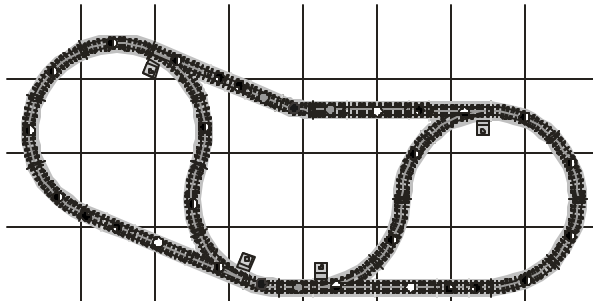

Track List:	Item #
(3) 10" Straight	(40-1001)
(12) O-31 Curved	(40-1002)
(2) O-31 Right Hand Switch	(40-1004)
(2) O-31 Left Hand Switch	(40-1005)
(3) 5.5" Straight	(40-1012)
(2) 5.0" Straight	(40-1016)
(5) 3.5" Straight	(40-1018)
(2) O-31 Half-Curved	(40-1022)

Approximate Layout Size:
96" x 48" (2.4m x 1.2m)

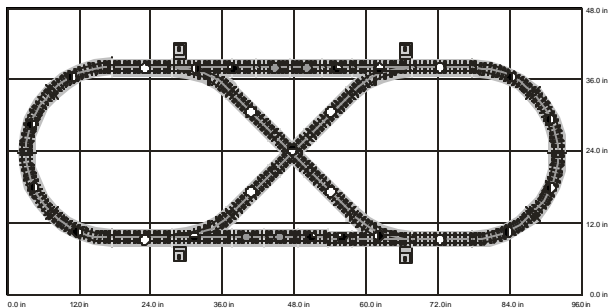

Track List:	Item #
(8) 10" Straight	(40-1001)
(8) O-31 Curved	(40-1002)
(2) O-31 Right Hand Switch	(40-1004)
(2) O-31 Left Hand Switch	(40-1005)
(1) 90 Degree Crossing	(40-1006)
(4) 5.5" Straight	(40-1012)
(2) 5.0" Straight	(40-1016)
(2) 4.25" Straight	(40-1017)

Approximate Layout Size:
52' x 36' (2.3m x 0.9m)

OverX.rnt
size: 4.00 x 4.00
track sections: 37

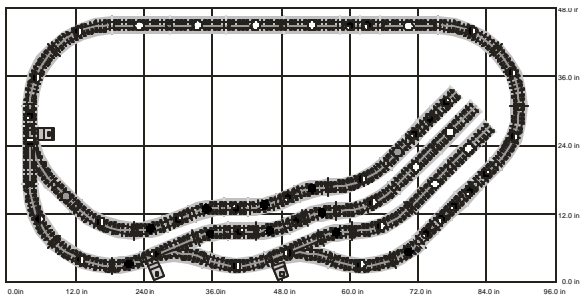

Track List:	Item #
(9) 10" Straight	(40-1001)
(13) O-31 Curved	(40-1002)
(2) O-31 Right Hand Switch	(40-1004)
(1) O-31 Left Hand Switch	(40-1005)
(2) 5.5" Straight	(40-1012)
(4) 5.0" Straight	(40-1016)
(2) 4.25" Straight	(40-1017)
(10) O-31 Half Curved	(40-1022)
(10) 3.5" Straight	(40-1018)

Approximate Layout Size:
90" x 48" (2.3m x 1.2m)

Scout.rnt
size: 8.00 x 4.00
track sections: 53

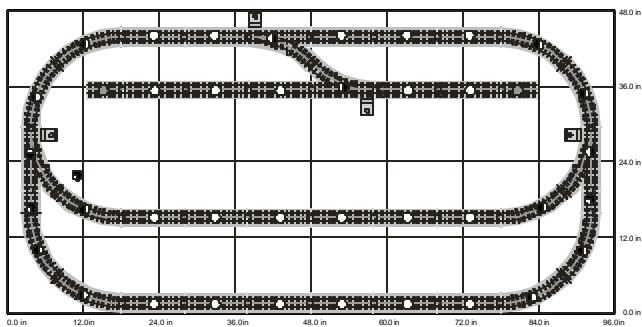

Track List:	Item #
(22) 10" Straight	(40-1001)
(10) O-31 Curved	(40-1002)
(3) O-31 Right Hand Switch	(40-1004)
(1) O-31 Left Hand Switch	(40-1005)
(2) 5.5" Straight	(40-1012)
(2) 3.5" Straight	(40-1018)

Approximate Layout Size:
96" x 48" (2.4m x 1.2m)

Sidings.rnt
size: 8.00 x 4.00
track sections: 40

Dockside 0-4-0

Parts

Name and Number	Part #
1.) Shell (# 840)(black) (JERSEY CENTRAL LINES)	FB-1200169
2.) Lens (headlight)	FA-1230022
3.) Handrail	FB-1200103
4.) Stanchion (black)	FB-1200024
5.) Bell	FB-1200101
6.) Name plate (# 840)	FB-1200170
7.) Screw (6/32X8.0mm)(roundhead)	IA-0000050
8.) Bolt (M3X10.0mm)(w/ 3.5X4.0mm oversized shank)	IA-0000265
9.) Bolt (M3X10.0mm)(w/ 2.0X4.0mm oversized shank)	IA-0000266
10.) Drive rod (56.3mm long)	EC-1250018
11.) Side rod (55.0mm long)	EC-1250019
12.) Crosshead	EC-1250016
13.) Drive rod guide (right)	EA-1210007
14.) Drive rod guide (left)	EA-1220007
15.) Screw (4/40X4.0mm)(roundhead)	IA-0000021
16.) Bulb (18V)(screw base)	CA-0230001
17.) Bracket	IH-0000088
18.) Screw (4/40X6.0mm [roundhead])	IA-0000003
19.) Smoke unit	AA-1200013
20.) Motor mount	BI-0000034
21.) Screw (M2.5X6.0mm)(roundhead w/ lock washer)	IA-0000089
22.) Screw (M2X4.0mm [roundhead])	IA-0000058
23.) Switch (small)	BB-0000009
24.) Drive block (2 axle)	DF-1200019
25.) Insulator (pick-up)(top)	BD-0000026
26.) Screw (M3X6.0mm [roundhead])	IA-0000015
27.) Motor	BE-0000045
28.) Board (reverse unit)	AC-0000007
29.) Nut (2.2X6.4X2.4mm)	IC-0000010
30.) Screw (4/40X12.0mm)(roundhead)	IA-0000264
31.) Bracket	IH-0000089
32.) Insulator (clear plastic) (17.5X41.0X0.5mm)	BD-0000064
33.) T-bar	IG-0000001
34.) Coupler	DD-0000011
35.) Armature	DD-0000012
36.) Spring (6.5X14.0mm) (w/ 0.5mm thick wire)	IE-0000022
37.) Washer (plastic)(black) (cup shaped for spring to fit in)(4.6X8.6X2.0mm) (inside 7.0X1.1mm)	ID-0000060
38.) E-clip (3.0X8.0X0.5mm)	IF-0000002
39.) Nut (2.5X5.0X7.0mm)	IC-0000008
40.) Insulator (pick-up)(bottom)	BD-0000024
41.) Pick-up (8.0X11.0mm roller)(28.0mm long)	BD-0000048
42.) Pick-up (8.0X11.0mm roller)(24.0mm long)	BD-0000050

*Requires Exchange

All parts are priced as each

Docksider 0-4-0

