



RAILKING 4-CAR SUBWAY SET OPERATING INSTRUCTIONS



Thank you for purchasing the RailKing R-42 4-Car Subway Set. The set's durable ABS bodies and die-cast trucks are patterned and decorated after the 1970 New York City Transit Authority cars. The cars should operate for years on any O-27 Gauge track with any compatible AC transformer (see the chart on page 28 for a list of compatible transformers) and are completely compatible with most 3-rail locomotives, rolling stock and accessories.

The 4-Car Subway Set contains one powered car that is equipped with a DCRU® electronic reverse unit and can be optionally equipped with the ProtoSound® Digital Sound and train control system which contains several deluxe features that are simple and fun to operate. Each feature is described among the following pages which should be read before the car is operated. For those of you who can't wait to get started, the *Quick Start Basic Operating Instructions* found on Pages 3 and 4 should be read so that you understand the basics of the operating system. Please note that some features are only found in the ProtoSound® models and are marked as such. Features not marked as ProtoSound® features are available in all models.

Table Of Contents

QUICK START - BASIC OPERATION	3
PROTOSOUNDS™ OPERATING INSTRUCTIONS	4
ProtoSound® DCRU® Reverse Unit Operation(All 3-Rail Models)	4
Horn Operation	5
Bell Operation	5
Squeaking Brake Sounds	6
Tips On Using Squeaking Brakes	7
Self-Recharging Battery Backup System	8
Subway Announcements (TAS)	9
Activating Subway Announcement Sounds	9
Tips On Using Subway Announcement Sounds	12
ProtoSound® Volume Adjustment	13
USING "RESET" TO PROGRAM PROTOSOUNDS™	
Entering RESET Options	13
Setting The Engine Volume	14
Programming For A Separate Bell Button Controller	15
Programming For Squeaking Brake Operation	16
Programming For Horn In Neutral Operation	17
Programming For TAS Operation	17
Activating Reverse Unit Lock-Out Control	17
Resetting All ProtoSound® Options To Factory Defaults	18
Reverse Unit Lockout Control Functions	19
Locking The Engine Into Forward or Reverse	19
Unlocking The Engine	19
Locking The Engine Into Neutral	19
Manual Reverse Unit Lockout	20
OIL & LUBRICATION INSTRUCTIONS	21
TRACTION TIRE REPLACEMENT INSTRUCTIONS	22
LIGHT BULB REMOVAL & REPLACEMENT	23
TROUBLE SHOOTING <i>PROTOSOUND</i>™ PROBLEMS	24
Transformer Wiring Chart	28
ProtoSound® RESET Feature Chart	29
SERVICE AND WARRANTY INFORMATION	30
HOW TO GET SERVICE	30
LIMITED ONE YEAR WARRANTY	30

QUICK START - BASIC OPERATION

The RailKing 4-Car Subway Set contains state-of-the art electronics with several built-in automatic features for incredibly realistic operation. Despite these advanced features, the 4-Car Subway Set is easy to operate with any compatible standard AC transformer (see the compatibility chart on page 28).

All models are controlled by a ProtoSound® DCRU® electronic reverse unit. The reverse unit operates in the same manner that all reverse units function by using forward, neutral and reverse states that are entered each time the throttle is turned on and off or by using the transformer direction switch (if so equipped).

The reverse unit is designed to ignore dirty track, dead spots on switches or minor short circuits without disrupting the engine operation, even at slow, prototypical speeds. Once the engine is placed on the track, the throttle on the transformer can be advanced. You will see that only the powered car's lights come on and that only two dings of the ProtoSound bell occur

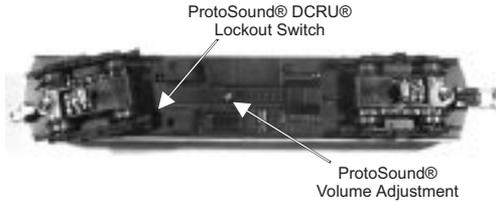
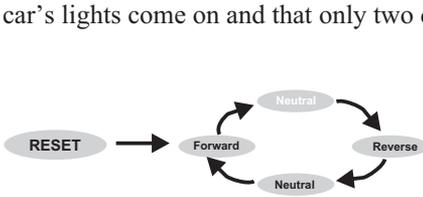

Figure 1: Locating The Powered Subway Car's switches



(on ProtoSound equipped 3-rail models). The car does not run. This is known as the RESET state and is explained in more detail beginning on Page 4. The ProtoSound® DCRU® will not power the motor until the throttle

is turned OFF and then ON again. At this point, the car will now function just like any other engine equipped with an electronic or mechanical E-unit. On ProtoSound-equipped cars, the motor sounds will change slightly in volume as the car begins to move. The horn can be activated by pressing the whistle button on the transformer just as any horn would be activated. See the sections later in this guide, beginning on page 5, for more information on activating the horn and bell sounds.

PROTOSOUNDS® OPERATING INSTRUCTIONS

The MTH ProtoSound® digital sound and train control system provides the operator with unprecedented realistic operation on your model railroad. In addition to actual Subway Set car CD-equivalent 16-bit digital sounds, you get the following features:

- * Built-In DCRU Reverse Unit * Authentic Horn Sound * Authentic Bell Sound * Squeaking Brake Sound * Subway Announcement Sounds * Self-Recharging Battery Back-Up System With Automatic Battery Shut-Off * Remotely Controlled Reverse Unit Lock-Out * Remotely Adjustable Engine Volume ***

Each feature is described among the following pages. Though the system is easy to use, we encourage you to read the instructions thoroughly.

PROTOSOUND® DCRU® REVERSE UNIT

As mentioned in the Basic Operating section, the car is controlled by a ProtoSound® DCRU® reverse unit that contains the standard forward-neutral-reverse states found on most reverse units. However, as described earlier, when power is first applied to the track, the reverse unit begins in RESET or what seems like a neutral state. Power must be interrupted again to get the car to enter the forward state. It is this first RESET state that gives ProtoSound® its unique, remote controlled functions. The system will enter RESET whenever power to the track is off for three or more seconds. NEUTRAL will be referred to as the state between Forward and Reverse.

ProtoSounds® is equipped with a microprocessor, that, depending on the amount of memory it is allotted, allows the user to utilize several remotely activated functions. In the simplest terms, ProtoSounds® has its own "Computer" controlling these functions. In fact, the power of this microprocessor is the same as that of a 286 desktop computer! In order to access many of these remotely controlled functions, the user must be in the RESET state to do so. RESET is entered anytime power to the locomotive has been off for more than 3 to 5 seconds. When the car first enters RESET, the microprocessor initiates a system check to determine if the system, transformer and car are operating correctly. This takes approximately 2.2 seconds. In order for ProtoSounds® to properly initiate the system check, do not advance the transformer throttle past 10 volts when you first enter RESET, then slowly turn the transformer throttle to the

off position and then back on again to enter the forward phase. Interrupting the power too quickly may cause the system to re-enter RESET (signaled by two dings of the bell). Should this happen, wait longer before interrupting the power to enter the Forward phase.

ProtoSounds® comes with several programmable functions, including Engine Volume Adjustment, Separate Bell Button Operation (pre-programmed at the factory), and Horn-In-Neutral Operation. Each of these features are described in more detail later. You will notice that when in RESET, your car will not respond to the whistle button with a horn blast or continuous bell ringing. In fact, when in RESET and the whistle button is depressed, only one single bell chime will be heard each time the whistle button is pressed. If you don't want to configure or change your car using any of these programmable features, simply leave RESET after waiting 2.2 seconds by interrupting the power to put the car in forward. After you leave RESET, your car will operate normally in all the direction states of forward, neutral and reverse.

HORN OPERATION

Your RailKing ProtoSound® equipped 4-Car Subway Set features a digital recording of a Subway Car horn. The horn sound can be activated anytime the car is in forward or reverse by pressing the whistle button on your transformer. The horn will continue to blow as long as the whistle button is depressed. The horn will not function in RESET and must be configured through a RESET option to allow the horn to work when the car is in neutral. See page 16 for information on horn programming in the *Using RESET To Program ProtoSounds®* section of this manual.

BELL OPERATION

Your RailKing ProtoSound® equipped 4-Car Subway Set features a digital recording of an actual Subway Car bell. Unlike previous versions of ProtoSounds®, the bell can be turned on or off with any separate bell button, like the Lionel® Railsounds® No. 5906 Bell Button, by simply pushing the button. If you don't have a separate bell button, the bell can be controlled through your transformer's whistle button whenever the car is in NEUTRAL. The bell will never ring continuously in RESET (Remember NEUTRAL is the state between Forward and Reverse). Once the bell is turned on, it will continue to ring when the car is cycled into forward or

reverse until you press and release the bell button or re-enter NEUTRAL and turn the bell off with the whistle button.

In fact, because of ProtoSounds® state-of-the-art design, the microprocessor remembers its last command. Therefore, unless you turn the bell off before you quit running your car, the next time you run the car, the bell will come on. No matter whether you come back an hour later or a year later, the bell will begin chiming once the car enters one of the three directional states.

Unlike most ProtoSound® equipped engines, the Subway Set version of the ProtoSound® software activates the bell in a slightly different manner. Normally, the bell is activated by pressing the bell button. With the Subway Set's unique Subway Announcement Sounds feature, the bell button is used to activate the Subway Announcements as well as to control the bell. In addition, since most Subways only used the bell to signal a start or stop sequence and rarely ran with the bell constantly running, use of the bell was normally quite limited. Nevertheless, the ProtoSound® equipped Subway Set bell can be controlled by a bell button. Instead of pushing the button on to start the bell sound, the operator must push and release the bell button quickly. Failure to release the button quickly will activate the Subway Announcement feature which is described on the following pages.

To turn the bell on using the transformer's whistle button, turn on power to the track and cycle the engine into NEUTRAL. Turn the throttle to 8 volts or less and press the whistle button. The bell should begin chiming. To turn the bell off, press the whistle button again. If you want to keep the bell on while running the car, simply interrupt the power with the transformer throttle or the transformer directional switch and enter forward or reverse.

PROTO-COUPLER™ OPERATION

Your RailKing Subway ProtoSound-equipped car contains a coil-wound ProtoCoupler® for remote uncoupling action. The coupler is mounted on the front power truck. Because the ProtoCoupler is controlled through ProtoSound's microprocessor, it doesn't require an uncoupling track section or modification to your layout to function. The three simple steps below are required to operate the coupler.

1. Put your engine in NEUTRAL and turn the throttle all the way up.
2. Press the transformer whistle button to "Arm" the coupler. (You will hear a "Clank")

3. After arming the coupler, press the whistle button again to open the coupler.

When the knuckle fires open you will hear the buzzing of the coil energizing and the sound of the air lines coming apart. It can best be described as a CHA-CHUSHHH sound.

The coupler doesn't have to be fired in NEUTRAL. Once the coupler is armed it can be fired in Forward, Neutral or Reverse.

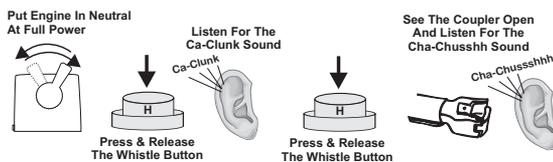

However, you may find that the coupler doesn't open when firing the coupler at high speeds. Reduce the voltage setting on your transformer if this occurs and run your engine at a slower speed before firing the coupler. If the coupler continues to open erratically, try lubricating the knuckle with light oil as indicated in Fig. 3 on page 22.

SQUEAKING BRAKE SOUNDS

ProtoSound® equipped engines feature the ability to play the sound of squeaking brakes whenever your car slows in speed. The Subway Set is shipped with a default setting that causes the brake sounds to play while the car is in forward or reverse and the transformer throttle is lowered from a high setting to a low setting (14 volts to 8 volts or less). The brakes can be turned off through a RESET setting explained later in this manual. The sound itself is a stored record on the ProtoSounds software chip and will always play the same brake sound for the same three second length each time the voltage is reduced from high to low.

Some practice may be required to synchronize the playing of the brake sounds with the movement of the car. It is not uncommon for the car to stop before the brake sound is completed. Operators will find that

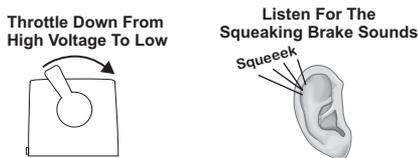

by coordinating the movement of the throttle setting from 8 volts to off will allow the car to maintain its movement while the brake sounds play. *Note: The brake sounds will not be heard if the transformer throttle is not set above 14 volts and/or not reduced below 8 volts.*

TIPS ON USING THE SQUEAKING BRAKE FEATURE

Because the squeaking brake feature always plays for approximately 3 seconds, it is possible that the brake sounds will play longer or shorter than what visually seems prototypical. You will find that by practicing with the brake feature, you can determine how quickly to throttle down and what speeds and voltage settings give you the most prototypical braking effect.

Typical users will find the feature to be a very realistic way to simulate the sound of a car slowing down for curves, crossings or coming to a stop at a station, side track or switch yard. As mentioned above, you will find that initially your car may continue to play the brake sounds once it comes to a stop or that the sounds stop prematurely before the car comes to a complete halt. For example, if you simply run the car and turn the throttle off quickly, the brake sounds will likely continue playing even though the car has come to a complete stop. This annoying effect can be eliminated by simply practicing with the brake feature. In no time, you will quickly learn how to “feather” the throttle to keep the car moving while the brake sounds play and then turning the throttle off just as the sounds stop.

The ProtoSound® squeaking brake feature also has the ability to simulate the squeal of wheel flanges when your car enters a curve at high speeds. The same brake squeaking sound plays, but you don’t need to reduce the transformer throttle to activate the squeaking sounds. To play the squeaking sounds as wheel flange sounds, you can trigger the brake feature with the whistle button on the transformer. As your engine enters a curve (or anywhere on the layout) quickly “flick” your transformer whistle button about half way. This “flicking” action causes the transformer to release a short DC signal that ProtoSounds® reads as an indicator to activate the brake sounds. The car won’t slow down even though the sounds play. This simulates the wheel flange squeal of a train travelling through a turn too quickly.

Note: Consistent activation of the wheel flange squeaking is determined by the condition of your transformer’s whistle button rectifier disc. Older rectifier discs may not release a clear and strong enough DC signal required by ProtoSounds® computer to play the wheel flange squealing.

SUBWAY ANNOUNCEMENTS (TAS)

ProtoSounds® is now equipped with operator controlled Subway announcement sounds, hereby known as TAS. This easy to use feature plays digitally reproduced Subway announcements and platform action sounds whenever you activate and stop your Subway Set car. No additional wires or modifications are needed on your layout to enjoy these amazing sound effects, though an option does exist that allows you to completely automate your Subway run activating the sounds at user specified locations. The sounds themselves are randomly generated and randomly “shuffled” on the ProtoSounds software chip. This gives the system the ability to produce different sounds in a different order each time the TAS feature is enabled. These different sounds are heard each time you cycle the transformer throttle from on to off in the same manner that you would cycle the throttle to enter the various states of forward, neutral and reverse. The entire TAS sequence is designed to simulate the arrival, disembarking, embarking, and departure of a Subway Set stop. The sounds include the Subway driver announcing the stop and the upcoming stop, passenger disembarking and embarking sounds, driver to passenger requests, door openings and closing and general subway platform action sounds. Each is described in more detail in the following sections.

ACTIVATING SUBWAY SOUNDS

Your ProtoSounds® equipped engine features an operator controlled Subway announcement sound set that can be activated in one of three ways, in automatic mode, manual mode or in layout controlled mode. Once activated, this easy to use feature plays digitally reproduced sounds of a Subway stop.

Option 1 - Automatic Mode: If you are using a separate bell button controller to ring your bell (like the Lionel Railsounds No. 5906 bell activation button) you can activate the feature by entering forward or reverse and pressing and holding the bell button for one second to signal the subway set to activate

the TAS feature. Continued holding of the bell button will be followed by a special “air let-off” sound

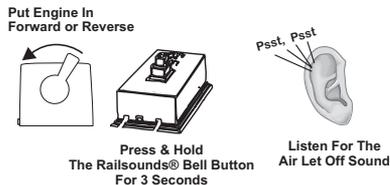

which indicates that a passenger wishes to exit the car at the current stop. At this point the operator should release the bell button if he wishes to stop the car. If the operator continues to hold the bell button down, the car will continue travelling down the track until the operator chooses to release the bell button. This option gives the operator the true sense of acting as the Subway driver. It also allows the operator to precisely control where the Subway Set does stop. This option is the default setting for the TAS feature.

Once the bell button is released, the Subway Set will come to an automatic stop even though power to the track has not been interrupted by the operator. Once stopped, the TAS feature will play the sound of the doors opening followed by the sounds of passengers leaving the cars and others arriving. During this event, the operator can expect to hear a variety of different sounds, including passing subway trains, passenger conversational sounds and the authentic sounds of a busy subway station. After a set period of time, the operator can expect to hear the standard “stand clear of the doors” message, followed by a double bell “ding, dong” and the sound of the car’s doors closing.



Release The Railsounds®
Bell Button To Stop The Car



Immediately following the door closing, the motor will be engaged and the Subway Set will automatically take off. The TAS feature will automatically start the car back up in the same direction it was travelling when the TAS feature was activated. So if the car was travelling forward before TAS was activated, it will continue travelling forward once TAS has completed.

Option 2 Manual Mode The TAS feature is armed in the same manner as Option 1, but instead, after the “air let-off” sound has played and the bell button released, the car will not automatically stop. To activate the rest of the TAS features, the operator must stop the car and place it in the neutral position by interrupting the transformer throttle. The car will not automatically start up again after the initial TAS sounds have played. Instead, the sounds will continue to repeat themselves giving the operator the ability to leave the car at the stop for longer periods of time. When the operator is ready to leave the stop, the transformer throttle must be interrupted again. This will be followed by the sound of a double bell “ding, dong” and the sound of the doors closing. After the door closing,

TAS will automatically reengage the motor and the set will proceed away from the Subway stop. Like Option 1, the set will continue on in the same direction it was traveling before TAS was activated.

Option 3 - Automatic Layout Configuration

The TAS feature in the Subway Set can be automatically triggered on a layout by configuring insulated pieces of track near the designated

Subway stops around the layout. The insulated track sections (center rail only) need to be attached to the transformer with a diode in the line to create a negative DC signal (the same signal created by the bell button) and be long enough that the signal will be outputted for at least 3 seconds (the time it takes to activate TAS by pressing the bell button). In short, the insulated track section and diode are acting like a bell button. Whenever the car runs through the insulated section, it will receive the negative DC signal and TAS will be activated. Because the diode reduces the power to the track, the car will also slow as it enters the insulated track section. The key to making this option effective is using a section long enough to create the 3 second “push” of negative DC without slowing the powered car to a complete halt. It is recommended that the operator attempt to have the rear

roller of the powered car leave the insulated track section shortly after the 3 second push of negative DC has been received by the ProtoSound® module inside the Subway Set powered car. This way, when TAS has completed its sequence, the powered car will be sitting on a track section with enough power to sufficiently get

the set moving again. Adjusting the overall track voltage will help adjust the speed necessary to carry the car through the insulated track section but

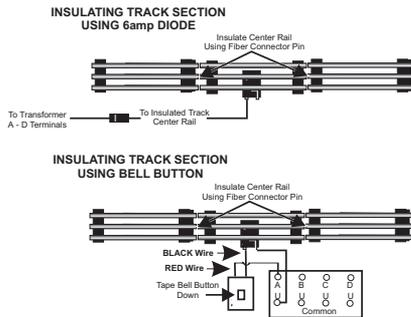
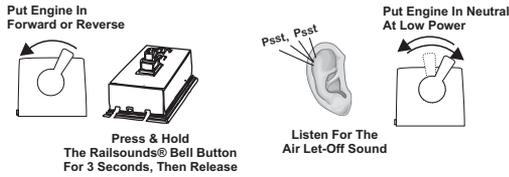

caution should be taken that not too much power is on the track or the car may pass through the insulated section before 3 seconds of negative DC was received by the ProtoSound® module. This will be obviously the case if the car's bell turns on instead of it stopping.

TIPS ON USING THE TAS FEATURES

TAS is a unique feature of ProtoSounds® that can be completely controlled by the operator or automatically configured on the layout. You decide how, when or if you want to utilize the feature. By reviewing the following tips you should find solutions or suggestions to the various operating scenarios you might encounter when using TAS.

Tip #1: You can escape the TAS sequence by turning the transformer throttle to OFF after TAS has been activated and waiting 3 seconds before turning the throttle back ON. This will return the car to the RESET position.

Tip #2: You do not have to be in the forward state to utilize TAS. For example if you activate the TAS feature while in reverse and interrupt the throttle to enter neutral, you will be entering neutral before forward rather than neutral before reverse as normally defined by the ProtoSound® sequencing. TAS, however, remembers what direction state the car was in before activation and will return the car to that same state upon completion of the TAS sequence, skipping the next direction state normally found in the ProtoSound® sequence. This will allow your car to leave the stop in the same reverse direction that it arrived in.

Tip #3: In Auto Mode, putting the car into Neutral immediately after the car stops (when TAS has been activated) will cause TAS to play 3 dings of the bell, play the door closing sound and repower the car into the forward mode.

Tip #4: In Auto Mode, putting the car into Neutral after the car stops (when TAS has been activated) and the sound of the car doors opening has played will cause TAS to play two dings of the bell, play the door closing sound and then proceed into the forward mode.

Tip #5: In the Track Configured Mode, interrupting the power while the car is travelling through the insulated track section will cause TAS to sound 3 dings of the bell, close the doors and proceed off in the reverse direction.

SELF-RECHARGING BATTERY BACKUP SYSTEM

ProtoSounds® state-of-the-art design includes a self-recharging battery backup system for improved performance at any speed. The self-recharging battery backup system is automatically turned on or off whenever track power is turned on or off. There are no switches to turn on or off to enjoy the benefits of the automatic battery backup system. The battery ensures that power to the sound system will remain on during directional changes, setting RESET options, or when traveling over dirty track and switches.

The battery is a rechargeable NiCad type which is continually charged from the track when power is applied. NiCad batteries are a dry battery and should not leak or cause any damage to your locomotive and will last up to five years or longer. If you notice that the sounds seem distorted or garbled at low voltages or become silent when power from the transformer is shut off, the battery charge may be low. Before replacing the battery, you should put the engine in NEUTRAL and leave the transformer throttle at about 12 volts for fifteen minutes. This should temporarily recharge the battery. If the garbled or distorted sounds are reduced, then your battery charge has worn down. You can give your battery a full charge by leaving the engine ON in NEUTRAL for 16 to 18 hours.

REPLACING THE PROTOSOUND BATTERY

The ProtoSound® battery is a special NiCad 7-cell, 8.4v battery - NOT the 6-cell, 7.2v battery found in most convenience stores. The 6-cell NiCad is NOT recommended for use with ProtoSound® applications. Replacement ProtoSound® batteries are available from MTH ProtoSound Electronics at 7020 Columbia Gateway Drive, Columbia, MD 21046-1532. A standard 9v alkaline battery can be substituted as a temporary fix, but since alkaline batteries can't take a charge, it will eventually wear down. Regardless, it should give you a week to a couple of months use while you wait for your replacement ProtoSound® battery to arrive.

PROTOSOUND® VOLUME ADJUSTMENT

Your ProtoSound® system has two types of volume adjustment. A manual turn knob on the bottom of the chassis (See Fig. 1, on Page 3) allows you to control all the sounds in the system and a remote control "RESET" option (Option # 6), allows you to control the volume level of the car motor sounds remotely from the transformer. Turning the volume adjustment knob clockwise will increase the volume and counterclockwise will lower the volume of all sounds; bell, horn, engine sounds, TAS, etc.

USING “RESET” TO PROGRAM PROTOSOUNDS®

As mentioned earlier, there are several programmable options in each ProtoSound® equipped engine that can be remotely set from any compatible standard AC transformer equipped with a whistle button. For a list of compatible transformers, see the chart on page 28. This hands-off approach gives you unprecedented control of your railroad empire’s motive power never before seen in model railroading. Each programmable feature can be accessed whenever your car is in the RESET state as described earlier on page 4. By following the instructions below you will find the programming easy and straight forward.

ENTERING RESET OPTIONS

ProtoSound® is equipped with a few programmable features that are accessed in the RESET state by moving the transformer throttle up and down between full voltage and low voltage (6 to 8 volts) without shutting the transformer off completely. Each time this is done you advance, one feature at a time, through the available options. An air-release sound is heard each time the throttle is advanced. In addition, there are special sounds to tell you what RESET position you are in.

For example, if you want to select Feature 2, you put the car in RESET, and move the throttle up and down from full throttle to low two times. After the second advance, you will hear two “clinks” indicating that the computer is now in Feature 2. Advance the throttle again and you will hear three “clinks” for Feature 3. Advance it two more times and you will hear a “clank” indicating that you are now in Feature 5. Advance the throttle two more times and you will hear a “clank” and two “clinks” indicating Feature 7. ((5 throttle advancements = 1 clank) + (2 throttle advancements = 2 clinks)). “Clank + “Clink” + “Clink” = Feature 7. You can advance the throttle as quickly as you like (though you may not hear the air-release sounds) and the computer will still remember the number of times the throttle is advanced by playing back the number of “Clinks” and “Clanks” to confirm the feature you’ve selected.

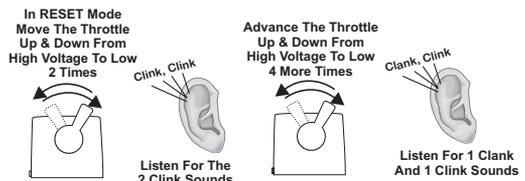

SETTING THE ENGINE VOLUME

Of all the sounds that come with each ProtoSound-equipped locomotive, the one most often turned down is that of the engine volume because it is the one sound normally heard whenever the engine is running and is what usually can become tiresome to the ear over prolonged running sessions. The volume adjustment is controlled through RESET Feature 6.

To access the feature, advance the transformer throttle to put the engine in RESET. Move the throttle up and down, as described on page 5, 6 times. After you hear the “clank” and “clink” indicating that you are in Feature 6, press the whistle button to select the engine volume you desire. Pushing the whistle button once will

give you full volume, which is the factory setting. Pushing the whistle button a second time will give you 50% volume, pushing it a third time will give you

25% volume and pushing it a third time will give you no sound. The microprocessor will immediately play the sound level each time the whistle button is pushed so that you can decide if it is acceptable. You can recycle through the four choices by simply continuing to push the whistle button.

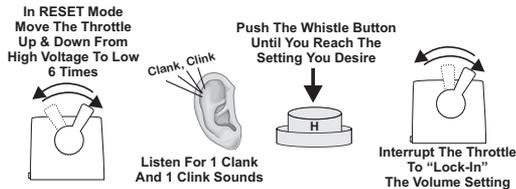

Once you have decided on the appropriate volume level, turn the transformer throttle off and on again or press the transformer direction switch to lock in your selection. The volume adjustment will remain set at the level you have chosen until you change it again. Regardless of the engine volume setting, the horn, bell, compressor and TAS sounds will function normally. In fact because only the engine volume is affected by selections in Feature 6, when you select 0 volume, you can still hear the horn, bell and TAS sounds when the engine is running or in neutral.

PROGRAMMING FOR A SEPARATE BELL BUTTON CONTROLLER

To operate ProtoSounds® with a separate bell button controller, like the Lionel® No. 5906 bell button, you will need to wire up the controller to your transformer and track as shown in Fig. 2. Once the button is wired, ProtoSounds® comes preprogrammed to allow you to operate the bell by simply pushing the bell button once. To turn the bell off, push the button

again. If the bell doesn't function when you press the button, you may need to re-program ProtoSounds to operate with a separate bell button controller. To do this enter RESET and go to Feature 20. (See the section *Using RESET To Program ProtoSounds®* on page 14.) Once in Feature 20, press the whistle button and wait for the module to sound a bell ding(s). Continue pushing the whistle button until the module plays back two dings (signifying that the module has been programmed for a bell button). Simply turn the throttle

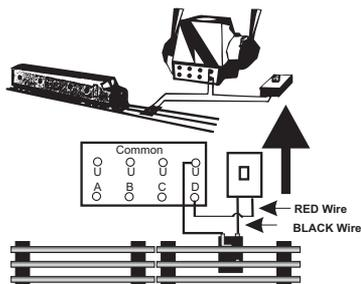
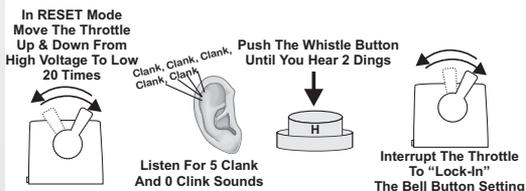

Figure 2: Wiring Up A Bell Button



off and then on again to "Lock-In" the new setting. To turn the bell button function off, repeat the above procedure but keep pushing the whistle button until the computer only responds with one bell ding.

PROGRAMMING FOR SQUEAKING BRAKE OPERATION

ProtoSounds® can be programmed for squeaking brake operation in three different manners; (1) Squeaking brakes can be activated by bell button control, (2) they can be programmed for continuous operation subject to throttle changes or (3) they can be programmed to be turned off. The default setting is (2) Squeaking brakes are activated for full-time operation as described on page 6. To change the default setting, enter RESET and go to Feature 45. (See the section *Using RESET To Program ProtoSounds®*



on page 14). Once in Feature 45, press the whistle button and wait for the module to sound a bell ding(s). Continue pressing the whistle button until the module plays back one ding for option 1 - Squeaking brakes are activated by the bell button with TAS operation. Press the whistle button again until the module plays back two dings for option 2 - squeaking brakes are activated for full-time operation, or press the whistle button again until the module plays back three dings for option 3 -Squeaking brakes off. Once you have decided on the desired setting, simply turn the throttle off and then on again to “Lock-In” the new setting. To reset the computer to its original factory default setting (option 2 - squeaking brakes are activated for full-time operation), repeat the above procedure but keep pushing the whistle button until the module only responds with two bell dings.

PROGRAMMING FOR HORN IN NEUTRAL OPERATION

If you are operating your car with a separate bell button and want to blow your horn when your car is in neutral, you will need to program ProtoSounds® to do so as the factory setting only allows the horn to blow in forward or reverse. To do this, enter RESET and go to Feature 25. (See the section *Using RESET To Program ProtoSounds®* on page 14.) Once in Feature 25, press the transformer whistle button and wait for ProtoSounds® to sound a bell ding(s).

Continue pressing the whistle button until ProtoSounds® sounds two bell dings (signifying that

ProtoSounds® has been programmed to sound the horn in neutral). Turn the throttle off and then on again to “Lock-In” your selection. Now, whenever you are in neutral, you can blow the horn with the transformer whistle button. To reset ProtoSounds® to its original factory setting of no horn in neutral, repeat the above procedure but keep pressing the whistle button in Feature 25 until ProtoSounds® only dings once instead of twice.

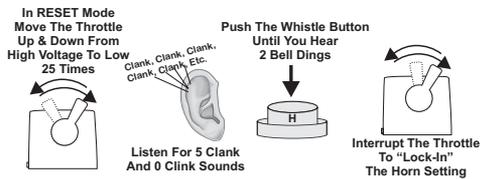

Note: When “Horn In Neutral” is set, the bell will only operate with a separate bell button and the horn will not sound in neutral if the transformer throttle setting is over 11 volts.

PROGRAMMING FOR TAS OPERATION

ProtoSounds® is equipped with a RESET setting to automatically select the Subway Announcement Proto-Effects Options (TAS) features. You also may want to configure TAS for manual operation or turn it off completely.

To configure TAS, enter RESET and go to Feature 28. (See the section on *Using RESET To Program ProtoSounds®* on page 14). Once in Feature 28,

press the transformer whistle button and wait for

ProtoSounds® to sound a bell ding(s). Continue pressing the whistle button on and off until ProtoSounds® sounds one bell ding(s) (signifying that the TAS feature has been turned off). Simply turn the transformer throttle OFF and then ON again to lock in the new setting. To reset ProtoSounds® to its original factory setting of Squeaking Brakes and TAS on, repeat the above procedure but keep pressing the whistle button in Feature 28 until ProtoSounds® dings 3 times instead of once. Interrupt the throttle by turning it OFF and then ON again to lock in the new setting. If you prefer TAS Option 3 - Manual Mode, repeat the above procedure but keep pressing the whistle button until you hear 2 bell dings instead of 3.

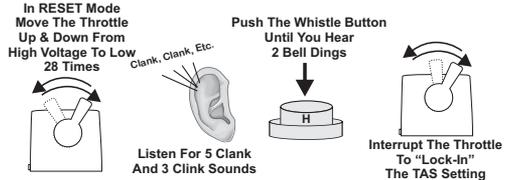

ACTIVATING REMOTE LOCK-OUT CONTROL

ProtoSound® equipped engines feature a RESET setting that allows the operator to remotely “lock” the engine into forward, neutral or reverse. This is especially useful on layouts that feature “blocked” track sections. The lockout feature comes from the factory in the OFF position, meaning it is not active when you first take the engine out of the box. This is done to prevent novice operators from accidentally locking their engine into forward, neutral or reverse and then mistakenly thinking that the engine’s electronics

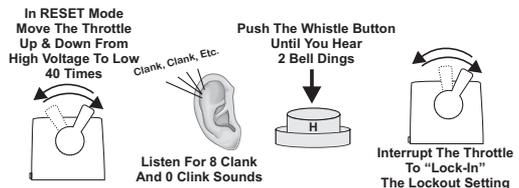

have failed. To activate the Remote Lockout Control setting, go to RESET Feature 40 (See the section entitled *Using RESET To Program ProtoSounds®* on page 14). Once in Feature 40, press the transformer whistle button and wait for ProtoSounds® to sound a bell ding. Continue pressing the whistle button until ProtoSounds® sounds two bell dings signifying that the Remote Lockout Control has been selected. To lock in the setting, simply turn the throttle all the way off and then back on again. To turn the Remote Lockout Control setting back off, go back to Feature 40 and press the whistle button until only one bell ding sounds. To lock in the setting, simply turn the transformer throttle off and then back on again. Alternatively, you can go to RESET Feature 18 to reset all ProtoSound® features back to their original factory defaults including Remote Lockout Control.

RESETTING ALL PROTO SOUND® OPTIONS TO FACTORY DEFAULTS

ProtoSounds® is equipped with a RESET feature (Feature 18) that resets all programmable options back to their original factory settings. This is a useful feature if you find

your engine not operating the way you think it should and don't want to take the time to check each RESET feature one at a time. To reset all the RESET features back to their original factory settings, enter RESET and go to

Feature 18. (See the section entitled *Using RESET To Program ProtoSounds®* on page 14). Once in Feature 18, press the transformer whistle button and wait for ProtoSounds® to sound a garbled bell sound. Interrupt the throttle again to lock in the setting.

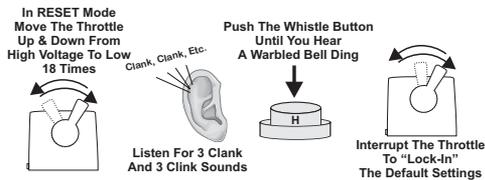

REVERSE UNIT LOCK-OUT OPERATION

ProtoSounds® unique design eliminates the need for a lock-out switch on the powered car by allowing the customer to lock the set into any directional state (forward, neutral or reverse) from the transformer. This will allow users to run the set on layouts equipped with block signals or stop stations which would normally cycle the engine back into neutral. The feature must be first turned on by accessing RESET Feature 40 (See section entitled *Using RESET To Program ProtoSounds®* on page 14).

LOCKING THE SUBWAY SET INTO FORWARD OR REVERSE

To lock the set into Forward or Reverse, use the transformer throttle to enter Forward or Reverse (whichever state you want to lock the set into) and while the set is moving press and hold the whistle button. WHILE THE HORN IS BLOWING TURN THE THROTTLE OFF AND THEN LET GO OF THE WHISTLE BUTTON. After about one second, you will hear a short horn blast. QUICKLY TURN THE THROTTLE BACK ON AGAIN. Your set is now locked into Forward or Reverse and it will remain so until you unlock the powered car, even if you wait a year to run your set again.

UNLOCKING THE SUBWAY SET

Unlocking the set is a similar procedure. WHILE THE SET IS MOVING, PRESS AND HOLD THE WHISTLE BUTTON. WHILE THE HORN IS BLOWING, TURN THE THROTTLE OFF AND THEN LET GO OF THE WHISTLE BUTTON. After three seconds without power you will hear one chime of the RESET bell. TURN ON THE POWER AGAIN. Your powered car is now in RESET and will operate normally once you interrupt power and enter the forward direction.

LOCKING THE SUBWAY SET INTO NEUTRAL

To lock the engine into the NEUTRAL position, PUT THE SET IN NEUTRAL AND WITH THE THROTTLE STILL ON, PRESS AND HOLD THE WHISTLE BUTTON. WHILE THE WHISTLE BUTTON IS BEING PRESSED, TURN OFF THE THROTTLE AND LET GO OF THE WHISTLE BUTTON. After about one second, you will hear a short blast

of the horn. **QUICKLY TURN THE POWER BACK ON AGAIN.** Your powered car is now locked into NEUTRAL.

***NOTE:** When locking the set in the Forward or Reverse positions, the whistle button will blow the horn. But when locking the set into the NEUTRAL position, the whistle button may turn on or off sounds of the bell, coupler arming or coupler firing depending on the transformer throttle voltage settings prior to the user's attempt to lock out the engine. Remember, the horn doesn't blow in NEUTRAL (unless you programmed it to do so using Feature 25. See page 17 for details), only the bell rings or the coupler operates in NEUTRAL. While it doesn't make any difference on how the lockout function operates, you may hear one of the three different NEUTRAL-activated sounds.*

To unlock the powered car from the NEUTRAL position, follow the process to unlock the set in the Forward or Reverse directions above.

NOTE: When the powered car is locked out in forward or reverse, TAS operation is disabled.

MANUAL REVERSE UNIT LOCKOUT (Non-ProtoSound® Equipped Sets)

Sets not equipped with ProtoSound® can be manually locked into Forward, Neutral, or Reverse by sliding the powered car's lockout switch to the OFF position after entering the desired reverse unit state (See Figure 1 on page 3). To operate the set again in automatic mode, simply slide the switch back to the ON position.

Note: Once the unit is locked out and an hour or more of non-use has passed, the reverse unit may cycle into any of the three directional states. Should this occur, the ON/OFF switch should be reset to the ON position to regain normal operation.

OIL & LUBRICATION INSTRUCTIONS

In order for the engine to perform correctly and quietly, it is important that the chassis be lubricated before operation. Lubrication should include all truck block bushings and pickup rollers to prevent them from squeaking.

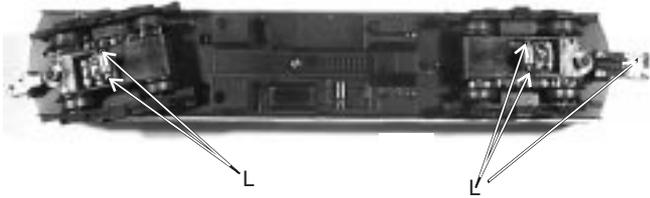

Figure 3: Lubricating The Locomotive Chassis

Use light household oil and follow the lubrication points marked “L” in Fig. 3 above.

The locomotive’s internal gearing in the power trucks has been greased at the factory and shouldn’t need additional grease until after 50 hours of operation or one year whichever comes first. Grease cannot be added to the internal gearing until the body is removed from the chassis which is held in place by four Phillips screws. The screws are located on each end of the chassis’ as seen in Fig. 5 on page 23. After removing the screws, lift the body away from the chassis and lay the body next to the chassis. Once the body has been removed, the interior detail must be removed to expose the motors. Remove the interior detail by unscrewing the four screws shown in Figure 5 and lift the interior out of the way.



Figure 4: Lubricate The Truck Bushings

Next, remove the power truck block from the chassis by unscrewing the large Phillips motor mount screw on the bottom of the power truck (See Fig. 5). Once the motor mount screw has been removed, pull the motor away from the truck block and lightly coat the motor worm gear and bronze drive gear (in the truck block) with grease. Reassemble the truck and motor, being careful not to pinch the pickup and ground wires between the truck block and motor mount. When reassembling the chassis and body, be very careful that the lighting wire harnesses are not caught between the body and chassis as this can lead to a short which may damage the electronic circuit boards beyond repair.

Periodically, check the locomotive wheels and pickups for dirt buildup as this can significantly affect the engine's ability to perform properly. Dirty track and dirty wheels can cause both poor electrical contact as well as poor traction, especially on elevated track sections. Finally, dirt and oil build up can prematurely wear out the neoprene traction tires.

TRACTION TIRE REPLACEMENT INSTRUCTIONS

Your Subway powered car is equipped with two neoprene rubber traction tires on the power truck. While these tires are extremely durable and long-lasting there may arise a time where they will need to be replaced. Should

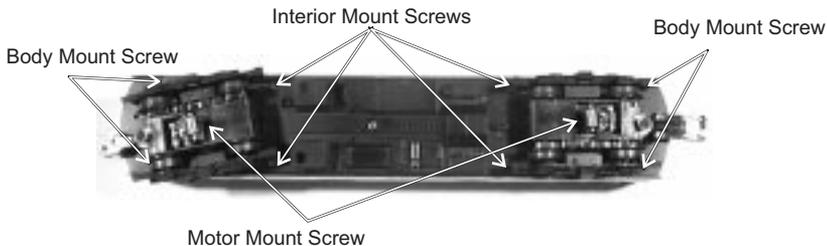

Figure 5: Removing The Body From The Chassis

this occur, you will need to remove the power truck from the chassis in order to slip the new tire over the grooved drive wheel. We suggest you follow the disassembly instructions found in the Lubrication section on the preceding pages to disassemble the chassis and truck blocks from the body.

Before the new tire can be installed, you must make sure the old tire has been completely removed from the groove in the drive wheel. Use a razor blade or small flatblade screwdriver pry away any remains left from the old tire that may still be in the drive wheel groove. Once the old tire has been completely removed, slip the new tire onto the wheel. You may find it useful to use two small flatblade screwdrivers to assist you in stretching the tire over the wheel. Be careful to avoid twisting the tire when stretching it over the wheel. If a twist occurs, the tire will have to be removed and reinstalled or a noticeable wobble in your engine will occur when operating the locomotive. In addition, it is important to make sure that the tire is fully seated inside the groove. Any portion of the tire extending out of the groove can cause the engine to wobble. A razor blade can be used to trim away any excess tire that doesn't seat itself inside the groove properly.

Once the new tire(s) are in place, reassemble the truck and the chassis to the body. Replacement tires are available directly from MTH Electric Trains.

HEADLIGHT REPLACEMENT

Each Subway Car contains interior bulbs that are controlled by the track voltage. The interior bulb simply plugs into its lamp socket and can be easily removed should the bulbs expire. To remove the bulbs, follow the cab removal instructions found in the lubrication section on the preceding pages. Once the cab has been removed from the chassis, gently pull the defective bulb from its lamp housing. In addition to the interior bulbs in the unpowered cars, the Subway Set powered car contains a constant voltage headlight and 2 end-of-car LED marker lights. All are connected to the electronics via quick-connect plug harnesses and can be replaced by simply pulling the bulb or LED harness out of the mounting socket inside the car's body. Replacement bulbs and harnesses are available directly from MTH Electric Trains.

TROUBLE SHOOTING *PROTOSOUND*®

PROBLEMS

Although ProtoSound® has been designed and engineered for ease of use, some questions may arise during initial operation. The following table should answer most questions. If you find that your problem can't be resolved with this manual, contact MTH ProtoSound® Electronics (7020 Columbia Gateway Drive, Columbia, MD 21046-1532, 410-381-2580) for additional assistance.

HORN PROBLEMS	REMEDY
The horn seems distorted at low voltages.	Your battery may be undercharged or dead. Try recharging the battery as explained in the battery sections.
When I press the whistle button, the bell comes on instead.	You are trying to operate the horn in neutral. The horn will only operate in Forward or Reverse unless you program ProtoSounds through Feature 25. See the instructions in the section entitled "Using RESET to Program ProtoSounds". The transformer leads may be wired to the track backwards. Reverse the lead connections to the transformer.
I can't get the horn to blow when I press the whistle button.	You may be pressing the whistle button too quickly. Most older AC transformers contain a two-step whistle button that releases a DC signal onto the track. It is this DC signal that tells the horn to blow. However, because the signal is weaker when the whistle button is depressed fully, the ProtoSound circuit may not recognize the signal. Try pressing the whistle button slower, taking approximately 1 second to fully depress the button.
BELL PROBLEMS	REMEDY
When I press the whistle button to activate the bell, the horn sounds.	You are trying to ring the bell in Forward or Reverse. The bell only operates in Neutral unless you have programmed ProtoSounds to recognize a separate bell button.
When I press the whistle button to activate the bell, I arm the coupler.	Reduce the voltage on the transformer before pressing the whistle button to activate the bell. The bell will only come on at 8 volts or less.
When I press the whistle button to activate the bell, the bell only rings once.	You are trying to ring the bell in RESET instead of neutral. Interrupt the power twice to enter Neutral, set the voltage at 8 volts or less and press the whistle button to activate the bell.
I can't get the bell to ring when I press the whistle button.	You may be pressing the whistle button too quickly. See the 3rd remedy in the horn section above.
The bell won't work with a separate bell button.	ProtoSounds must be programmed in order for a separate bell button to function. Enter RESET function number 20 (see the section entitled "Using RESET to Program ProtoSounds") and press the whistle button until the bell sounds two dings. Simply turn the throttle off and then on again to lock in the new setting.

LOCKOUT PROBLEMS	REMEDY
I can't get the car to run after I power up the transformer. It sits still with the lights on.	The engine is locked out into the Neutral position. Follow the unlocking procedures in the Lockout Section.
The engine won't lock out into Forward, Neutral or Reverse even after the short horn blast sounds.	You are waiting too long to turn the throttle back on after the short horn blast sounds. The power must be turned back on immediately after the short horn blast sounds or the engine will go back into RESET. See the lockout procedure in the Lockout Section.
VOLUME PROBLEMS	REMEDY
When I try to run the car, the motor volume is OFF or very low.	The motor volume has been programmed at a reduced volume or to be silent. Go to RESET Feature 6 and adjust the volume. See the section entitled "Using RESET to Program ProtoSounds" for more information.
When I try to set the motor volume, it resets itself to the original volume after I selected the new volume.	You are trying to set the volume with a poorly charged or dead backup battery. See the section on Battery Backup for more information.
When I try to set the Motor Volume to O Volume, I still hear the TAS sounds.	When the motor volume is set to O, you will hear the TAS sounds because setting the motor volume only controls the sound of the car itself. All other sounds, including TAS, the horn and bell will continue to play at the volume level set by the manual volume control knob located on the bottom of the chassis. See the section entitled "ProtoSound Volume Adjustment" for more information.
The sounds seem distorted, especially when the whistle or bell is activated.	The overall ProtoSound volume has been set to high creating the distorted sounds. Try turning the volume control knob located on the bottom of the chassis counter clockwise to reduce the overall volume level.
BATTERY PROBLEMS	REMEDY
I get no sounds when the engine shifts between the direction states.	The battery may be dead or needs charging. See the Battery Backup section for more information.
After I turn off my transformer, my engine continues to make sounds before quitting with a ding of its bell.	ProtoSounds continues to sound for approximately 10 seconds after power to the track has been shut off.
The sounds distort at low voltages.	The battery is insufficiently charged or dead. Follow the recharging instructions found in the section entitled "Self Recharging Battery Backup System".
A repeating horn blast occurs after the power has been shut down.	ProtoSounds includes a built-in analyzation test that checks for correct functioning. If a repeating horn blast is heard when power is OFF, your car should be returned to the factory for service.
RESET PROBLEMS	REMEDY
When I first turn the power on, the engine will not begin to run. I have to turn the throttle off and then again to get the engine to operate.	This is normal behavior. When power to the track is first turned on, ProtoSounds enters a "RESET" phase at which time the engine undergoes a system check. Power must be interrupted to get the engine into the Forward Phase. See the section entitled "DCRU Reverse Unit Operation" for more information.
Whenever I interrupt the power from RESET to enter Forward, the engine goes back into RESET instead of Forward. I know this occurs because the bell dings twice.	Whenever ProtoSounds enters RESET after power has been off for more than 15 seconds, the microprocessor initiates a system check to determine that everything is in working order. This system check requires 2.2 seconds to complete. We recommend that you don't interrupt the power in RESET until the 2.2 seconds have elapsed. This will guarantee that the system check will have been completed since the startup sounds take longer than 2.2 seconds to play. If the problem persists, we recommend that you operate the throttle with a slower movement as you interrupt the power in RESET and enter the Forward Phase.

BRAKE SOUND PROBLEMS	REMEDY
When the transformer is throttled down, the sounds won't play.	The brake feature has not been activated. See the section on activating the brake feature for more information. The throttle voltage setting on the transformer is either not starting high enough or ending low enough to trigger the brake sounds. Try increasing the throttle setting to 14 volts or higher before throttling down to 8 volts or less.
The brake sounds continue to play even after the engine stops.	The brake feature sound record lasts for three seconds. With practice you can control how quickly you should stop the engine to keep it in sequence with the sound of the brake's squeaking.
The brake feature was activated in neutral after the engine was running in forward, but the brake sounds would not play when triggered after the engine went back into forward or reverse.	The brake feature will only remain enabled if it is triggered in the first direction state you enter after activating the feature in neutral. You cannot interrupt the power twice to enter another direction state and still have the brake feature active. Therefore, in order to make the brake sound feature operate in forward, you must first activate the feature in the neutral position that occurs after the engine was in the reverse state.
TAS PROBLEMS	REMEDY
The TAS feature does not begin even after stopping the engine and hearing the brake sounds.	The power was disconnected once the car entered the neutral state thus disabling TAS. The transformer throttle was interrupted after the car stopped, ending the TAS sequence. Don't touch the throttle once the TAS sequence begins.
The TAS sound effects occasionally repeat themselves.	ProtoSounds has a built-in random number generator that randomly selects each sound clip to play. Because there are only a total of 8 sound clips available in each TAS event, it is probable that a sound can occasionally be repeated one or more times.
Once in TAS, the engine never goes in reverse.	So that the trolley announcement sound effects and operation is as realistic as possible, ProtoSounds disables the reverse unit state whenever TAS is enabled. This way the engine never goes into reverse as the operator cycles into and through the TAS events.

TRANSFORMER WIRING CHART

ProtoSounds® is designed to work with any standard AC transformer that uses a “Pure Sine-Wave” format. The chart below lists the many Lionel® compatible transformers, such as the Lionel KW or ZW models. In addition, the chart details how the terminals on these compatible transformers should be attached to your layout. The Trainmaster system from Lionel® (marked with an asterisk below) will not function correctly

Transformer Model	Center Rail	Outside Rail	Min/Max. Voltage	Power Rating	Transformer Type
Lionel 1032	U	A	5-16v*	90-Watt	Standard
Lionel 1032M	U	A	5-16v*	90-Watt	Standard
Lionel 1033	U	A	5-16v*	90-Watt	Standard
Lionel 1043	U	A	5-16v*	90-Watt	Standard
Lionel 1043M	U	A	5-16v*	90-Watt	Standard
Lionel 1044	U	A	5-16v*	90-Watt	Standard
Lionel 1053	U	A	8-17v	60-Watt	Standard
Lionel 1063	U	A	8-17v	60-Watt	Standard
All-Trol	Left Terminal	Right Terminal	0-24v	300-Watt	Electronic
Cab-1/Powermaster	A	U	0-18v	135V. A.	Electronic
Dallee Hostler	Left Terminal	Right Terminal			
Lionel LW	A	U	8-18v	75-Watt	Standard
Lionel KW	A or B	U	6-20v	190-Watt	Standard
MRC Tech II	Left Terminal	2 nd From Left	0-15v*	40V. A.	Electronic
Lionel MW (not recommended)	Outside Track Terminal	Inside Track Terminal	5-16v*	50V. A.	Electronic
R. O. W.	Red Terminal	Black Terminal	0-24v	384-Watt	Standard
Lionel RS-1	Red Terminal	Black Terminal	0-18v	50V. A.	Electronic
Lionel RW	U	A	9-19v	110-Watt	Standard
Lionel SW	U	A	Unknown	130-Watt	Standard
Lionel TW	U	A	8-18v	175-Watt	Standard
Lionel ZW	A or D	U	8-20v	275-Watt	Standard
MTH Z4000	Black	Red	5-21v	400-Watt	Standard

with ProtoSounds® without disrupting the sound effects. Therefore, whenever ProtoSounds® senses that the Trainmaster system is being used, it automatically disables ProtoSounds® sound effects. The operator retains control over the engine, but no sound effects will play.

**ProtoSounds needs over 14 volts of power to work properly. Overloading or using in-line accessories with this transformer may lower the peak voltage below ProtoSound's requirements.*

PROTOSOUND RESET FEATURE CHART

The following chart lists the available features found in your ProtoSound® equipped locomotive. The default settings for each feature as well as the operation sequence of the feature are listed in separate columns. You can reset all features to their original factory settings by accessing Feature 18 in RESET and press and hold the transformer whistle button until you hear a soft, warbled bell sound.

RESET #	OPERATION	DEFAULT	CLANKS/CLINKS
6	Engine Volume	Full Volume	1 Clank/1 Clinks
10	RESERVED		2 Clanks/0 Clinks
18	Reset Default Settings		3 Clanks/3 Clinks
20	Remote Bell Button	Bell Button Active	4 Clanks/0 Clinks
23	RESERVED		4 Clanks/3 Clinks
25	Horn In Neutral	Horn In Neutral OFF	5 Clanks/0 Clinks
27	RESERVED		5 Clanks/2 Clinks
28	Brake/TAS Enabled	Brake/TAS ON	5 Clanks/3 Clinks
40	Lockout Enabled	Lockout OFF	8 Clanks/0 Clinks
45	Squeaking Brakes	Brakes Always ON	9 Clanks/0 Clinks

O-27 OPERATION

While the RailKing Subway Set is more than capable of operating on O-27 curves and switches, you may find that certain layout configurations may be prone to causing occasional derailments of the unpowered cars. Should this occur, we suggest restricting the speed through these track configurations or reconfiguring the track, switches or other accessories that may be causing the derailments.

SERVICE & WARRANTY INFORMATION

HOW TO GET SERVICE UNDER THE TERMS OF THE LIMITED ONE YEAR WARRANTY

For warranty repair, do not return your product to the place of purchase unless it was purchased from Mike's Train House in Columbia, MD. Instead, follow the instructions below to obtain warranty service as our dealer network is not prepared to service the product under the terms of this warranty.

1. First, write, call or FAX MTH Electric Trains, 7020 Columbia Gateway Drive, Columbia, MD 21046-1532, 410-381-2580 (FAX No. 410-381-6122), stating when it was purchased and what seems to be the problem. You will be given a return authorization number to assure that your merchandise will be properly handled upon its receipt.
2. CAUTION: Make sure the product is packed in its original factory packaging including its foam and plastic wrapping material so as to prevent damage to the merchandise. The shipment must be prepaid and we recommend that it be insured. *A cover letter, including your name, address, daytime phone number, Return Authorization number, a copy of your sales receipt and a full description of the problem, must be included to facilitate the repairs. Please include the description regardless of whether you discussed the problem with one of our service technicians when contacting MTH for your Return Authorization number.*
3. Please make sure you have followed the instructions carefully before returning any merchandise for service.

LIMITED ONE YEAR WARRANTY

This item is warranted for one year from the date of purchase against defects in material or workmanship. We will repair or replace (at our option) the defective part without charge for parts or labor, if the item is returned to the address below within one year of the original date of purchase. This warranty does not cover items that have been abused or damaged by careless handling. Transportation costs incurred by the customer are not covered under this warranty.

This warranty gives you specific legal rights and you may have other rights which vary from state to state.

ProtoSounds® is a trademark of MTH Electric Trains. DCRU® is a registered copyright of QS Industries, Inc. Lionel® and Railsound® are registered trademarks of Lionel L.L.C. MTA, MTA New York City Transit and the MTA's logos are trademarks of the State of New York Metropolitan Transportation Authority.