



# F59 PH Diesel Locomotive Set

## OPERATOR'S MANUAL



### Compatibility

This engine will operate on any traditional O-31 Gauge track system, including M.T.H.'s RealTrax<sup>®</sup> or ScaleTrax<sup>™</sup> or traditional tubular track. It is also compatible with most standard AC transformers. (See page 19 for a complete list of compatible transformers and wiring instructions.)



Passenger Station Announcements



**PLEASE READ BEFORE USE AND SAVE**

# Table of Contents

<b>Set Up Checklist</b> .....	3
Lubrication.....	3
Checking The Battery.....	3
<b>Basic Operation</b> .....	4
Activating Features.....	4
<b>Configuring For Display</b> .....	5
<b>Proto-Sound 2.0 Operating Instructions</b> .....	6
Activating Proto-Sound 2.0 Conventional Mode Features.....	6
Passenger Station Announcements (PSA).....	7
Speed Control.....	9
Locking Locomotive Into A Direction.....	10
Reset To Factory Default.....	10
Automatic Sound Effects.....	10
<b>Maintenance</b> .....	11
Lubricating and Greasing Instructions.....	12
Cleaning The Wheels, Tires and Track.....	12
Traction Tire Replacement Instructions.....	13
Headlight Replacement Instructions.....	14
Self Charging Battery Back-Up.....	14
Troubleshooting Proto-Sound® 2.0 Problems.....	16
Transformer Compatibility and Wiring Chart.....	19
Additional Features Accessible Of DCS Remote Control System.....	20
Service & Warranty Information.....	21
Limited One-Year Warranty.....	21

**CAUTION: ELECTRICALLY OPERATED PRODUCT:**

Not recommended for children under 10 years of age. M.T.H. recommends adult supervision with children ages 10 - 16. As with all electric products, precautions should be observed during handling and use to reduce the risk of electric shock.

**WARNING:** When using electrical products, basic safety precautions should be observed, including the following: Read this manual thoroughly before using this device.

- M.T.H. recommends that all users and persons supervising use examine the hobby transformer and other electronic equipment periodically for conditions that may result in the risk of fire, electric shock, or injury to persons, such as damage to the primary cord, plug blades, housing, output jacks or other parts. In the event such conditions exist, the train set should not be used until properly repaired.
- Do not operate your layout unattended. Obstructed accessories or stalled trains may overheat, resulting in damage to your layout.
- This train set is intended for indoor use. Do not use if water is present. Serious injury or fatality may result.
- Do not operate the hobby transformer with damaged cord, plug, switches, buttons or case.

# Set Up Checklist

- Lubricate the locomotive
- Check to see whether the battery needs to be charged for full sound effects
- Apply power to run as described in the Basic Operating Section of this manual

## Lubrication

You should lubricate the engine to prevent it from squeaking. Use light household oil and follow the lubrication points marked “L” in Fig. 1. Do not over-oil. Use only a drop or two on each pivot point.

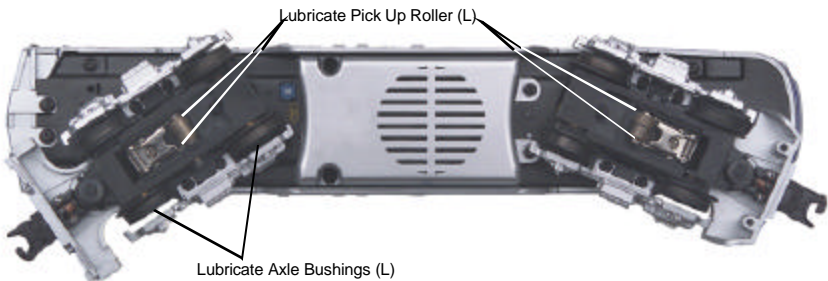

*Figure 1. Lubrication Points on the Locomotive*

## Checking The Battery

You may find, if your locomotive was built several months before you set it up, that the rechargeable battery has run down and needs to be charged before operating. If you notice that the sounds are garbled, test and charge the engine as described in the "Self-Charging Battery Back-Up" on page 14.

# Basic Operation

The Throttle knob controls how fast your train will travel.

Turn the throttle knob up ½-way, until the engine and caboose lights shine bright.

Put the engine into motion by pressing the Direction button on your transformer once. (hold it for approximately 1 second)

If the engine does not begin to move as soon as you firmly press the Direction button, you may not have sent enough voltage to the track to make the train move. Turn the throttle up a bit higher until the train begins to move.

## Activating Features

**Throttle** To increase or decrease track voltage, and therefore train speed, turn the throttle control knob. Turning clockwise will increase voltage and speed, while turning counterclockwise will decrease voltage and speed. The engine will maintain the speed you set after you release the throttle until you turn it again to change the voltage and speed.

**Bell** - To sound the bell, in an engine equipped with a bell firmly press and release the Bell button. To turn the bell off, press and release the Bell button again. The bell will continue to ring from the time you turn it on until you press and release the button again to turn it off.

**Horn/Whistle** - To sound the whistle, firmly press the Horn/Whistle button. The whistle will sound for as long as you continue to depress the button. It will stop when you release the button.

**Direction** Your train is programmed to start in neutral. The train will always cycle neutral-forward-neutral-reverse with each press and release of the direction button. The engine is programmed to restart in neutral each time the track voltage is turned off for 25 seconds or more.

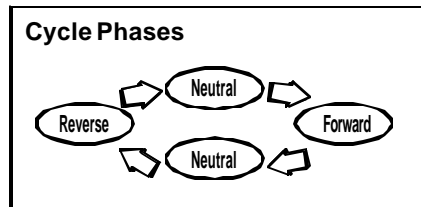

## Manual Volume Control

To adjust the volume of all sounds made by this engine, turn the master volume control knob located next to the fuel tank clockwise to increase the volume and counter-clockwise to decrease the volume.

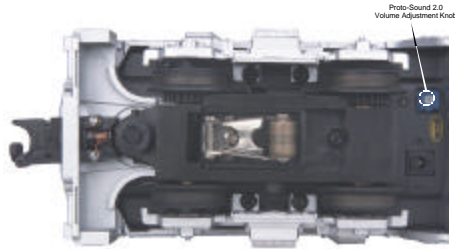

*Figure 2: Manual Proto-Sound 2.0 Volume Adjustment*

# Proto-Sound 2.0

## Operating Instructions

This manual contains the operating instructions for Proto-Sound 2.0 in conventional mode only. Instructions for accessing DCS command mode features accompany the DCS Remote Control System equipment.

### Activating Proto-Sound 2.0 Conventional Mode Features

Proto-Sound 2.0 features are activated by sequences of Bell and Horn button pushes described below. Please read the full descriptions of each feature before using it. To use these buttons to activate features rather than to blow the horn or ring the bell, you should tap the buttons very quickly with a ½-second pause between button presses. You may need to practice your timing to make this work smoothly.

Timing Chart				
Press Horn Short & Firm	½ Sec. Pause	Press Bell Short & Firm	½ Sec. Pause	Press Bell Short & Firm
Total Time Lapse: 1 ½ Seconds				

Feature to Be Activated	Button Code:
Passenger Station Announcements	1 Bell, 2 Horns
Fire the Rear Coupler	1 Bell, 3 Horns
Fire the Front Coupler	1 Bell, 4 Horns
Speed Control On/Off	1 Horn, 2 Bells (from Neutral only)
Lock into a Direction	1 Horn, 3 Bells
Reset to Factory Defaults	1 Horn, 5 Bells (from Neutral only)

# Passenger Station Announcements (PSA)

Your engine is equipped with a sound package of passenger station announcements that you can play when you pull into a station. Each sequence described below will play as long as it is left on, randomly generating sounds, but be sure to allow approximately 30 seconds between the button pushes described below to allow the PSA sufficient time to run through each sequence.

- To cue the sound system to play the PSA, quickly but firmly tap the Bell button once followed by 2 quick taps of the Horn button while the engine is moving. Tap the buttons quickly but allow approximately 1/2 second between each press.
- Press the Direction button once to stop the engine. This will trigger the first sequence of PSA. The reverse unit is temporarily disabled so that the train will not move as you use the Direction button to trigger the sounds, and Proto-Sound 2.0 has disabled operator control over the Horn and Bell buttons until the full PSA sequence is complete.
- After waiting about 30 seconds for that sequence to run, press the Direction button again to trigger the second sequence of PSA.
- After about 30 seconds, press the Direction button again to trigger the third PSA sequence.
- Again, after allowing about 30 seconds for that sequence to run, press the Direction button one more time to trigger the fourth and final PSA sequence. The PSA will continue, and within a few seconds, the engine and bell will start and move out on its own at the current throttle setting, in the same direction it was traveling when you began the sequence. Once the bell turns off, the operator regains control of the transformer's bell and Horn buttons and can ring the bell or blow the Horn as usual.

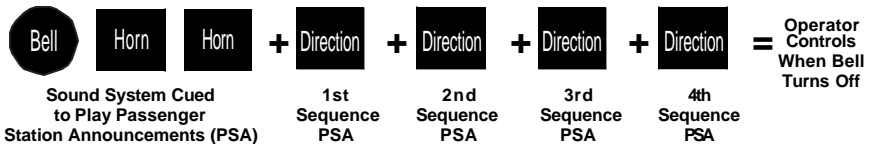

## Tips on Using PSA

- You can terminate PSA at any time by turning off power to the track for 15 seconds.
- You do not have to be in Forward to use PSA. At the conclusion of the full sequence, the train will pull away from the station in whatever direction you were going when you activated the feature.
- You can use PSA even if you are double-heading with another engine. If the second engine is not equipped with Proto-Sound 2.0, you must remember not to leave the throttle at a high voltage level once you have stopped the engine to run the PSA. Otherwise, the engine without PSA will begin vibrating on the track as its motors strain to move the train, since they cannot be automatically disabled during the PSA cycle (or if an original Proto-Sound engine, PSA are triggered differently and that engine's motor-disable feature will not be active when you run PSA in Proto-Sound 2.0).
- PSA can be triggered from Neutral. It will operate the same as if triggered while in motion except that, at the conclusion of the PSA, the engine will depart in the next direction of travel, as opposed to the direction it was traveling before entering Neutral.



# Speed Control

M.T.H. engines equipped with Proto-Sound 2.0 have speed control capabilities that allow the engine to maintain a constant speed up and down grades and around curves, much like an automobile cruise control. You can add or drop cars on the run, and the engine will maintain the speed you set.

While the engine is programmed to start with the speed control feature activated, you can opt to turn it off. This means the engine's speed will fall as it labors up a hill and increase as it travels downward. It is also affected by the addition or releasing of cars while on the run. Because the engine will run more slowly at a given throttle voltage when speed control is on than when it is off, you should adjust the throttle to a lower power level for operation with speed control off to avoid high-speed derailments. When speed control is off, the volume will drop to allow for better low voltage operation.

**To turn speed control on and off**, put the engine in neutral, then quickly tap the transformer's Horn button one time then quickly tap the Bell button two times, allowing approximately 1/2 second to lapse between each quick button press. Two horn blasts will indicate that the engine has made the change. Repeat the 1 horn, 2 bells code to return it to the other condition. You will want to do this during the initial neutral upon start-up if you ever couple this engine to another engine that is not equipped with speed control to avoid damaging the motors in either engine. Each time you shut down the engine completely, it will automatically turn speed control on.



Place  
Engine into  
Neutral



=

**Speed Control**  
**Two Horn Blasts**  
(indicates change is made)  
**Repeat to Return**  
**to Normal Condition**

# Locking Locomotive Into A Direction

You can lock your engine into a direction (forward, neutral, or reverse) so that it will not change directions. To do this, put the engine into the direction you want (or into neutral to lock it into neutral), run it at a very slow crawl (as slowly as it will move without halting), and quickly but firmly tap the Horn button once followed by three quick taps of the Bell button, allowing approximately 1/2 second to lapse between each quick button press. Two horn blasts will indicate that the engine has made the change. The engine will not change direction (including going into neutral) until you repeat the 1 horn, 3 bells code to return the engine to its normal condition, even if the engine is kept without power for extended periods of time.

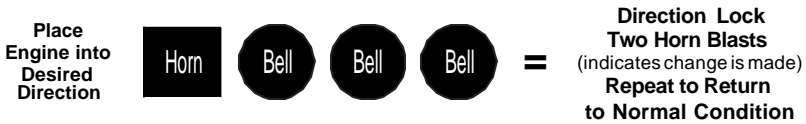

# Reset To Factory Default

To override the settings you currently have assigned to the engine and reset it to its factory defaults, while in Neutral tap the Horn button quickly once, followed by five quick taps of the Bell button, allowing approximately 1/2 second to lapse between each quick button press. Two horn blasts will indicate that the engine has made the change.

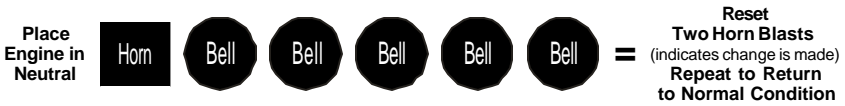

# Automatic Sound Effects

Certain Proto-Sound 2.0 sound effects automatically play in programmed conventional mode conditions:

- Squealing Brakes play any time the engine's speed decreases rapidly.
- Cab Chatter plays at random intervals when the engine idles in neutral.
- Engine Start-up and Shut-down sounds play when the engine is initially powered on or is powered off for five seconds or more.

# Maintenance

## Lubricating and Greasing Instructions

The engine should be well oiled and greased in order to run properly.

Regularly lubricate all axles and linkage components and pickup rollers to prevent squeaking. Use light household oil, such as that found in M.T.H.'s maintenance kit. Do not over oil. Use only a drop or two on each pivot point.

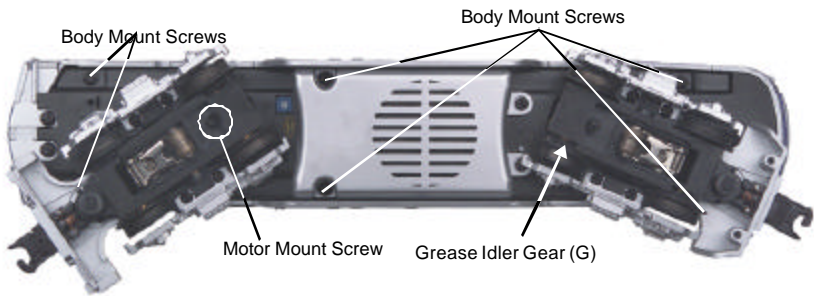

Figure 3

The locomotive's internal gearing was greased at the factory and should not need additional grease until after 50 hours of operation or one year, whichever comes first. Follow the greasing instructions below. Note that in some tightly packed engines you may need to move internal components temporarily in order to access the gears.

1. To access the gear box, remove the cab from the chassis by unscrewing the chassis screws as seen in Figure 3 and lifting the cab from the chassis.
2. Once the cab is removed, remove the trucks by unscrewing the black Phillips motor mount screw located on the underside of the drive trucks (see Fig. 4).
3. Once the motor mount screw has been removed, pull the motor away from the truck block and lightly coat the motor worm gear and bronze drive gear (in the truck block) with grease.
4. Reassemble the truck and motor, being careful not to pinch any wires between the truck block and motor mount.

5. After repeating the procedure for the other motor, reassemble the chassis and body, being careful that the wire harnesses are not caught between the chassis and body and reinstall the chassis screws.

Lubricate the outside truck block idler and drive gears with grease. Use the diagram shown in Figure 4 as a guide and add grease to the points marked with a “G.”

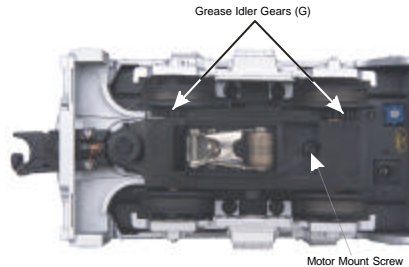

Figure 4

## Cleaning The Wheels, Tires and Track

Periodically check the locomotive wheels and pickups for dirt and buildup, which can cause poor electrical contact and traction as well as prematurely wear out the neoprene traction tires.

Periodically check the locomotive wheels and pickups for dirt and buildup, which can cause poor electrical contact and traction and prematurely wear out the neoprene traction tires. Wheels and tires can be cleaned using denatured (not rubbing) alcohol applied with a cotton swab.



To clean the track, use RailKing Track Cleaning Fluid and a clean rag or denatured (not rubbing) alcohol. Unplug the transformer and wipe the rails of the track, turning the rag frequently to ensure that you are using clean cloth on the rails. Thereafter, keep an eye on the track and clean it when it gets dirty to ensure good electrical contact and to lengthen the life of the tires.

# Traction Tire Replacement Instructions

Your locomotive is equipped with two neoprene rubber traction tires on each powered truck block. While these tires are extremely durable, you may need to replace them at some point.

First, remove the truck sides from the truck block. To do this, turn your engine upside down and remove the chassis as detailed on page 11.

Remove the trucks from the chassis and the truck sides from the trucks in order to slip the new tire over the grooved drive wheel.

Once the truck sides have been removed:

1. Make sure the old tire has been completely removed from the groove in the drive wheel, using a razor blade or small flathead screwdriver to pry away any remains.
2. Slip the new tire onto the wheel. You may find it useful to use two small flathead screwdrivers to stretch the tire over the wheel.
3. If you twist the tire while stretching it over the wheel, you will need to remove and reinstall the tire. Otherwise your engine will wobble while operating.
4. Make sure the tire is fully seated inside the groove. Use a razor blade to trim away any excess tire that will not seat inside the groove properly.
5. Reassemble in the reverse order.

Replacement parts and wick replacement instructions are available directly from the M.T.H. Parts Department (order online: [www.mth-railking.com](http://www.mth-railking.com), e-mail: [parts@mth-railking.com](mailto:parts@mth-railking.com); mail: 7020 Columbia Gateway Drive, Columbia MD 21046-1532, FAX: 410-381-6122).

# Headlight Replacement Instructions

The locomotive's headlight is controlled by a constant voltage circuit in the engine. The headlight is easy to remove and replace when it burns out. The bulb has a quick disconnect plug that attaches the bulb harness to a light circuit. Replacement bulbs are available directly from the M.T.H. Parts Department.

Follow the body removal instructions found in the Lubrication and Greasing Instructions.

Gently push down and turn to the left, pull out and replace the bulb.

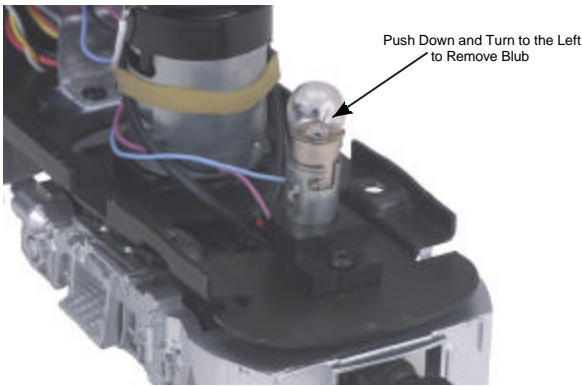

Figure 5

## Self Charging Battery Back-Up

The special NiCad 7-cell 8.4v self-charging battery recharges continuously during train operation and should last for up to five years. The battery is a dry battery that should not leak or cause any damage to your engine. Depending upon when your engine was built, it may need to be charged right out of the box. If engine sounds seem distorted or garbled at low voltages or become silent when power from the transformer is turned off, test the battery to determine whether it should be recharged or replaced.

**Test:** Put the engine in neutral and leave the track voltage at 10-12 volts (high enough for the lights to shine brightly and the engine to move steadily) for 15 minutes.

**Recharge:** If the sounds are improved at the end of the 15-minute test charge, the battery charge has run down and can be recharged. There are a number of ways you can do this:

- Leave the engine in neutral with track voltage at 10-12 volts for 6-7 hours so the battery can fully recharge (if your engine has a smoke unit, be sure it is turned off).
- Use M.T.H.'s battery recharger (sold separately) that plugs into a wall outlet and a special port under the engine to recharge the battery overnight without leaving it on the track.

**Replace:** If the sounds are not improved at the end of the 15-minute test charge, it is time to replace the battery. Available through M.T.H. Parts. A standard 9v alkaline battery can be substituted until your replacement arrives, but since alkaline batteries cannot be recharged, it will eventually wear down. Do NOT use a 6-cell 7.2v battery.

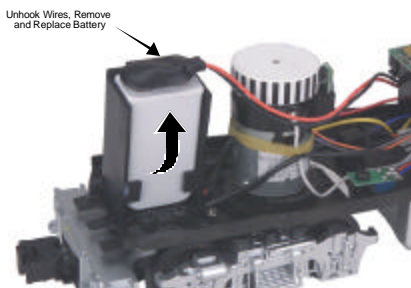

Figure 6

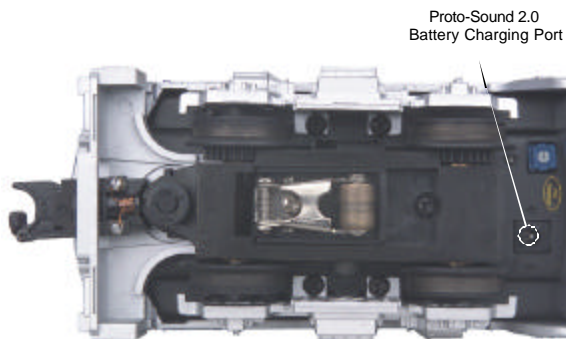

Figure 7

# Troubleshooting Proto-Sound® 2.0 Problems

Although Proto-Sound 2.0 has been designed and engineered for ease of use, you may have some questions during initial operation. The following table should answer most questions. If your problem cannot be resolved with this table, contact M.T.H. for assistance (telephone: 410-381-2580; fax: 410-423-0009; service@mth-railking.com, 7020 Columbia Gateway Drive, Columbia MD 21046-1532).

<b>Starting Up</b>	<b>Remedy</b>
When I first turn the power on, the engine will not begin to run. I have to turn the throttle off and then on again to get the engine to operate.	This is normal behavior. To prevent accidental high-speed start-ups, Proto-Sound 2.0 is programmed to start up in neutral anytime track power has been turned off for several seconds. See the "Basic Operation" section for more details.
<b>Horn</b>	<b>Remedy</b>
When I press the whistle button, the bell comes on instead.	Reverse the transformer leads.
I can't get the horn to blow when I press the whistle button.	You may be pressing the button too quickly. Try pressing the whistle button more slowly, taking approximately one full second to fully depress the button.
<b>Bell</b>	<b>Remedy</b>
When I press the whistle button, the bell sounds.	Reverse the transformer leads.
I can't get the bell to ring when I press the bell button.	You may be pressing the button too quickly. Try pressing the bell button more slowly, taking approximately one full second to fully depress the button.
The bell won't work on a separate bell button.	Check the wiring of the separate button.
<b>Coupler</b>	<b>Remedy</b>
When I try to fire the coupler, PSA starts.	You are waiting too long between whistle button presses.
The Proto-Coupler won't let the engine uncouple on the fly.	Try lubricating the coupler knuckle with a dry graphite lubricant. Do NOT use oil.



<b>C ab Chatter</b>	<b>Remedy</b>
Sometimes the Cab Chatter sounds don't play.	Cab Chatter plays only in neutral.
<b>Lock-out</b>	<b>Remedy</b>
I can't get the engine to run after I power up the transformer. It sits still with the engine sounds running.	The engine is locked into the neutral position. Follow the procedure in the "Lock into a Direction" section.
The engine won't lock into forward, neutral, or reverse.	Engine speed must be below 10 scale mph (approx. 10 volts or less in conventional mode).
<b>Volume</b>	<b>Remedy</b>
The sounds seem distorted, especially when the whistle or bell is activated.	Proto-Sound 2.0 volume is set too high. Turn the volume control knob on the bottom of the chassis counter-clockwise to reduce the volume.
<b>B attery</b>	<b>Remedy</b>
The engine will not leave the initial neutral setting	Check to be sure the battery is installed and fully charged. See the "Self-Charging Battery Back-Up" section.
I get no sounds when the engine shifts between directions.	The battery may be dead or need to be charged. See the "Self-Charging Battery Back-Up" section.
After I turn off my transformer, my engine continues to make sounds before quitting.	Proto-Sound 2.0 is designed to continue to sound for a few seconds after power to the track has been shut off.
<b>PSA</b>	<b>Remedy</b>
The PSA sounds occasionally repeat themselves.	Proto-Sound 2.0 has a built-in random number generator that randomly selects each sound clip to play. Because there are a limited number of sound clips available in each PSA sequence, it is probable that some of these sound clips will be repeated from time to time.

PSA	Remedy
Once in PSA, the engine doesn't go into reverse.	So that PSA effects can be as realistic as possible, Proto-Sound 2.0 disables the reversing unit whenever PSA is enabled. This way the engine remains still at its stop as the operator cycles through the PSA sequences.
When the PSA enters its last sequence the bell automatically comes on.	PSA is programmed to start ringing the bell at that point. After approximately 12 rings of the bell, it will automatically turn off.
When PSA is enabled, pressing the whistle and bell buttons has no effect.	Because PSA must control various effects in each sequence, Proto-Sound 2.0 takes control of these sound effects until you exit PSA.
I push the direction button but the next sound clip in the sequence does not play or the engine does not come out of PSA after fourth press of the direction button.	Each PSA clip must play for approx. 30 seconds before PSA will advance to the next step in the PSA cycle. Wait at least 30 seconds in each PSA sound clip before pressing the direction button.

# Transformer Compatibility and Wiring Chart

Proto-Sound 2.0 is designed to work with most standard AC transformers. The chart below lists the many compatible transformers. Note that many of the operational commands described in these instructions require a bell button, so if your transformer does not have its own bell button, you should consider adding one to get the full benefit of the system. In addition, the chart details how the terminals on these transformers should be attached to your layout.

Transformer Model	Center Rail	Outside Rail	Min/Max. Voltage	Power Rating	Transformer Type
MTH Z-500	Red Terminal	Black Terminal	0-18v	50-Watt	Electronic
MTH Z-750	Red Terminal	Black Terminal	0-21v	75-Watt	Electronic
MTH Z-4000	Red Terminal	Black Terminal	0-22v	390-Watt	Electronic
Lionel 1032	U	A	5-16v	90-Watt	Standard
Lionel 1032M	U	A	5-16v	90-Watt	Standard
Lionel 1033	U	A	5-16v	90-Watt	Standard
Lionel 1043	U	A	5-16v	90-Watt	Standard
Lionel 1043M	U	A	5-16v	90-Watt	Standard
Lionel 1044	U	A	5-16v	90-Watt	Standard
Lionel 1053	U	A	8-17v	60-Watt	Standard
Lionel 1063	U	A	8-17v	60-Watt	Standard
All-Trol	Left Terminal	Right Terminal	0-24v	300-Watt	Electronic
Dallee Hostler	Left Terminal	Right Terminal			Electronic
Lionel LW	A	U	8-18v	75-Watt	Standard
Lionel KW	A or B	U	6-20v	190-Watt	Standard
Lionel MW	Outside Track Terminal	Inside Track Terminal	5-16v	50V.A.	Electronic
Lionel RS-1	Red Terminal	Black Terminal	0-18v	50V.A.	Electronic
Lionel RW	U	A	9-19v	110-Watt	Standard
Lionel SW	U	A	Unknown	130-Watt	Standard
Lionel TW	U	A	8-18v	175-Watt	Standard
Lionel ZW	A,B,C or D	U	8-20v	275-Watt	Standard
Lionel Post-War Celebration Series ZW	A,B,C or D	Common	0-20v	135/190 Watt	Electronic

\* Conventional Mode Only

# Additional Features Accessible With The DCS Remote Control System

(Additional equipment required)

While conventional mode operation of a Proto-Sound 2.0 engine yields wonderfully realistic sound and several train control features, command mode operation allows the user to access a world of command functions never before accessible to O Gauge railroaders. With the addition of the DCS Remote Control System (including a DCS remote handheld and Track Interface Unit) users gain many advanced features, including:

- DCS Proto-Speed Control - Establishes desired locomotive speed in scale miles per hour increments via a thumbwheel control and allows operator to set maximum speed and acceleration/deceleration rates
- ProtoSmoke® Variable Output Control - Controls how much smoke each engine outputs and matches smoke to locomotive speed
- Locomotive Lighting Control - Controls locomotive headlights, marker and interior lights, beacon lights, ditch lights, and MARS lights
- Emergency Stop-Single button push stops all Proto-Sound 2.0 trains but does not turn off the power
- One Touch Global Mute/UnMute-Single button mutes or unmutes all DCS-controlled locomotives' user-defined actions, including sound, lights, and smoke
- Proto-Dispatch Operation-Public Address-like feature allows users to speak through locomotive speaker during operation
- Proto-Cast-Allows users to play audio recordings through locomotive speaker during operation
- Proto-Doppler Sound Effects Set Up-Users can configure locomotive for Doppler Operation, including setting distance points for Doppler start, repeat, and stop modes
- Independent Volume Control of Engine Sounds, Bell, Horn & Whistle for each Locomotive
- Control up to 50 different DCS-Equipped Locomotives at one time with multiple TIUs
- Proto-Effects™ Set Up-User can select individual Proto-Effects™ operations to be active or inactive, including cab chatter, train wreck sounds, coupler sounds, and wheel clickety-clack sounds
- Direction Control Set Up-User can set initial individual start-up direction (start in forward or reverse) for double-heading operations
- Locomotive Consist Set-up-User can determine locomotive values for consist make-ups, allowing multiple locomotives belonging to a consist to operate together

# Service & Warranty Information

## How to Get Service Under the Terms of the Limited One-Year Warranty

For warranty repair, follow the instructions below to obtain warranty service.

First, e-mail, write, call or fax an Authorized M.T.H. Service Center in your area or M.T.H. Electric Trains to obtain Repair Authorization. You can find the list of Authorized Service Centers on the M.T.H. website, [www.mth-railking.com](http://www.mth-railking.com). Authorized Service Centers are required only to make warranty repairs on items sold from that store; all other repairs may or may not be done at the store's own discretion. Otherwise, contact M.T.H. (fill out the Service Contact form in the Service Section of [www.mth-railking.com](http://www.mth-railking.com); send US mail to the address listed below; tel: 410-381-2580; fax: 410-423-0009), stating when the item was purchased and describing the problem. If you contact M.T.H., you will be given a return authorization number to assure that your merchandise will be properly handled upon its receipt.

**CAUTION:** Make sure the product is packed in its original factory packaging including its foam and plastic wrapping material so as to prevent damage to the merchandise. The shipment must be prepaid and we recommend that it be insured. *A cover letter including your name, address, daytime phone number, e-mail address (if available), Return Authorization number, a copy of your sales receipt and a full description of the problem must be included to facilitate the repairs. Please include the description regardless of whether you discussed the*

## Limited One-Year Warranty

All M.T.H. products purchased from an Authorized M.T.H. Train Merchant are covered by this warranty.

See our website at [www.mth-railking.com](http://www.mth-railking.com) or call 1-888-640-3700 to identify an Authorized M.T.H. Train Merchant near you.

M.T.H. products are warranted for one year from the date of purchase against defects in material or workmanship, excluding wear items such as light bulbs, pick-up rollers, batteries, smoke unit wicks, and traction tires. We will repair or replace (at our option) the defective part without charge for the parts or labor, if the item is returned to an Authorized M.T.H. Service Center or M.T.H. Electric Trains within one year of the original date of purchase. This warranty does not cover damages caused by improper care, handling, or use. Transportation costs incurred by the customer are not covered under this warranty.

Items sent for repair must be accompanied by a return authorization number, a description of the problem, and a copy of the original sales receipt from an Authorized M.T.H. Train Merchant, which gives the date of purchase. If you are sending the item to M.T.H., fill out the Service Contact form in the Service Section of [www.mth-railking.com](http://www.mth-railking.com); send US mail to the address listed below; call 410-381-2580, or fax 410-423-0009 to obtain a return authorization number. If you are sending this product to an Authorized Service Center, contact that Center for their return authorization.

This warranty gives you specific legal rights, and you may have other rights that vary from state to state.

Service Department  
M.T.H. Electric Trains  
7020 Columbia Gateway Drive  
Columbia MD 21046-1532



**MTH**  
ELECTRIC TRAINS®

**AUTHORIZED SERVICE CENTER**

**7020 Columbia Gateway Dr. - Columbia, MD 21046**  
**Information: 410-381-2580 Fax: 410-381-6122**  
[www.mth-railking.com](http://www.mth-railking.com)

## PARTICIPATING RETAILER LIST

### ALABAMA

SOUTHERLAND STATION  
 HUNTSVILLE  
 256-533-4720  
[railway@bellsouth.net](http://railway@bellsouth.net)

### ARIZONA

ARIZONA TRAIN DEPOT  
 MESA  
 480-833-9486  
[sales@arizonatraindepot.com](mailto:sales@arizonatraindepot.com)  
[www.arizonatraindepot.com/](http://www.arizonatraindepot.com/)

### CALIFORNIA

DOLLHOUSES, TRAINS & MORE  
 NOVATO  
 415-883-0388  
[kbecker@cmc.net](mailto:kbecker@cmc.net)

### TIN PLATE JUNCTION

OAKLAND  
 510-444-4780  
[TOYTRAINS@email.msn.com](mailto:TOYTRAINS@email.msn.com)

### COLORADO

MIZELL TRAINS Inc  
 WESTMINSTER  
 303-429-4811  
[mizelltrains@cs.com](mailto:mizelltrains@cs.com)  
[www.mizelltrains.com](http://www.mizelltrains.com)

### CONNECTICUT

SHELTON RAILROAD SYSTEMS  
 SHELTON  
 203-924-8761  
[adriani@clearlight.com](mailto:adriani@clearlight.com)  
 NEW ENGLAND HOBBY SUPPLY  
 MANCHESTER  
 860-646-0610  
[bobbell@nehobby.com](mailto:bobbell@nehobby.com)

### DELAWARE

K R R B MODEL TRAINS INC.  
 NEWARK  
 302-292-2779  
[info@krbb.com](mailto:info@krbb.com)  
[www.krbb.com](http://www.krbb.com)

### FLORIDA

DEPOT HOBBY SHOP  
 LAKE WORTH  
 561-585-1982  
[jimmy11982@aol.com](mailto:jimmy11982@aol.com)  
[www.depothobbies.com](http://www.depothobbies.com)

### COLONIAL PHOTO & HOBBY

ORLANDO  
 407-841-1485  
[trains@colonialphotoandhobby.com](mailto:trains@colonialphotoandhobby.com)

### WARRICK CUSTOM HOBBIES

PLANTATION  
 954-370-0708  
[info@warrickcustomhobbies.com](mailto:info@warrickcustomhobbies.com)  
[www.warrickcustomhobbies.com](http://www.warrickcustomhobbies.com)

### FRANK'S TRAINS & HOBBIES INC.

OLDSMAR  
 813-855-1041  
[FTH@allhobbies.com](mailto:FTH@allhobbies.com)  
[www.allhobbies.com](http://www.allhobbies.com)

### READY TO ROLL

MIAMI  
 305-688-8868  
[rttrains@aol.com](mailto:rttrains@aol.com)  
[www.readytorolltrains.com](http://www.readytorolltrains.com)

### ILLINOIS

BIKE & CHOO CHOO CONNECTION  
 SCHAUMBURG  
 847-882-7728  
[trainconnection@aol.com](mailto:trainconnection@aol.com)

### INDIANA

Y. O. R. K. TRAINS  
 MUNSTER  
 219-838-9999  
[yorktrains@aol.com](mailto:yorktrains@aol.com)

### SAMUELSON'S TRAIN SHOP

VALPARAISO  
 219-462-2708

### LOUISIANA

AMERICA'S TRAIN YARD  
 BATON ROUGE  
 225-926-5592

### MAINE

WHEELS, WINGS & THINGS  
 LUDLOW  
 207-532-6277  
[irc44@javanet.com](mailto:irc44@javanet.com)

### MARYLAND

ENGINE HOUSE HOBBIES  
 GAITHERSBURG  
 301-590-0816  
[lucciecerise@aol.com](mailto:lucciecerise@aol.com)

### J & B TRAINS

HAGERSTOWN  
 240-420-4930

### HOBBYTOWN U S A

FREDERICK  
 301-694-7395

### PURKEY'S TOY TRAINS

SYKESVILLE  
 410-549-6061  
[wiley@oldmainline.com](mailto:wiley@oldmainline.com)

### THE TRAIN ROOM

HAGERSTOWN  
 301-745-6681

### MASSACHUSETTS

NORTHEAST TRAINS  
 PEABODY  
 978-532-1615  
[www.netrains.com](http://www.netrains.com)

### MICHIGAN

BRASSEUR ELECTRIC TRAINS INC.  
 SAGINAW  
 517-793-4753  
[bob@traindoctor.com](mailto:bob@traindoctor.com)  
[www.traindoctor.com](http://www.traindoctor.com)

**MISSOURI**

SWITCH STAND  
SAINT LOUIS  
314-781-4458  
r41877@earthlink.com

**MARK TWAIN HOBBY CENTER**

ST. CHARLES  
636-946-2816  
webmaster@hobby1.com  
www.hobby1.com

**NEW HAMPSHIRE**

TREASUREDTOYS  
SALEM  
603-898-7224  
ttoys@treasured-toys.com  
www.treasured-toys.com

**RAILROAD SPECIALTIES**

HUDSON  
603-882-5566  
crew@electric-trains.com  
www.electric-trains.com

**NEW JERSEY**

TRAINS & THINGS  
TRENTON  
609-883-8790  
trainsanthings@aol.com

**GRAND CENTRAL STATION**

KEARNY  
201-955-6200  
228gene@gateway.com

**HOBBYMASTERS, INC**

RED BANK  
732-842-6020  
hobbymasters@hobbymasters.com

**HOLLY BEACH TRAIN DEPOT**

WILDWOOD  
609-522-2379  
larry@pro-usa.net

**COAST TRAINS AND COLLECTIBLES**

WALL  
732-556-9005  
coasttrain@aol.com  
www.coasttrains.com

**J & B TRAINS, INC.**

MAPLE SHADE  
856-414-0092  
BASE1130@aol.com

**HOBBY SHOP**

MATAWAN  
732-583-0505  
hobbyshopnj.com

**ATLANTIC RAILS**

HAMMONTON  
609-567-8490  
bobcap@pics.com  
www.atlanticrails.com

**COUNTRY AND STUFF**

ANDOVER  
973-786-7086  
stuff@crystal.palace.net

**RIDGEFIELD HOBBY**

RIDGEFIELD  
201-943-2636

**COLUMBUS TRAIN STATION**

COLUMBUS  
609-518-1800

**NEW YORK**

AURORA RAILS & HOBBIES  
EAST AURORA  
716-652-5718  
rk82141@aol.com

**AMERICANA STORE**

TIVOLI  
845-757-4246  
mthdepot@valstar.net

**NASSAU HOBBY CENTER, INC.**

FREEPORT  
516-378-9594  
Charlienassau@aol.com

**KROSS HARDWARE**

WEST BABYLON  
631-669-3069  
1989@aol.com

**CITY DEPOT, INC.**

NEW HAMPTON  
845-374-3010  
citydepot@frontiernet.net  
www.citydepot.com

**NORTH CAROLINA**

DRY BRIDGE STATION  
MOUNT AIRY  
336-786-9811  
mikek@drybridgestation.com  
www.drybridgestation.com

**THE FREIGHT YARD**

SMITHFIELD  
919-934-6229  
disbissette@aol.com

**TRAINS LTD.**

CHARLOTTE  
704-566-9070  
modelrns@bellsouth.net  
www.trainstld.com

**THE ROUNDHOUSE & BACKSHOP**

CARY  
919-465-0810

**OHIO**

DIXIE UNION STATION  
MASON  
513-459-0460  
rockylane@core.net  
www.dixieunionstation.com

**RICK'S TOY TRAINS**

TOLEDO  
419-478-0171

**T & K HOBBY SHOP**

BRIDGEPORT  
740-633-6607  
salea@tkhobbies.com  
www.tkhobbies.com

**TRAINS-N- THINGS**

CANTON  
330-499-1666  
trains@sssn.net

**PARMA HOBBY**

CLEVELAND  
216-741-6440  
info@parmahobby.com

**GLEN'S TRAIN SHOP**

AKRON  
330-253-6527

**E & S TRAINS**

AKRON  
330-745-0785

**GRAND PACIFIC JUNCTION**

OLMSTEAD FALLS  
440-235-4777  
gpjmrr@juno.com  
HUDSON TOY, TRAIN & HOBBY  
HUDSON  
330-653-2997  
epickers@aol.com

**DAVIS ELECTRONICS**

MILFORD  
513-831-6425  
davisrains@fuse.net  
www.davisrains.com

**SANDY'S HOBBY'S & COLLECTIBLES**

ELYRIA  
440-365-9999  
sandyshobb@aol.com

**ERIE RAILWAY DEPOT**

TROY  
937-440-9972  
orville@gte.net

**CLEARVIEW TRAIN & HOBBY**

LORAIN  
440-277-4488  
klogar@erienet.net  
www.clearviewtrainandhobby.com

**PENNSYLVANIA**

FAIRCHANCE PHARMACY  
FAIRCHANCE  
724-564-7817  
mhdealer@aol.com  
www.hhs.net/fairchance

THE STATION  
NEW CUMBERLAND  
717-774-7096  
station@paonline.com  
BUSSINGER TRAINS  
AMBLER  
215-628-2366  
choochoos@icdc.com  
www.icdc.com/~btrains

CHARLEROI SWEEPER CENTER  
CHARLEROI  
724-483-3397

AMERICAN HOBBY CENTER  
ALIQUIPPA  
724-378-3930  
american@icubed.com

CRANBERRY HOBBY DEPOT  
CRANBERRY TWP  
724-776-3640  
JAdams6113@aol.com

ALLENTOWN TOY TRAIN SERVICE  
ALLENTOWN  
610-821-0740

ON THE RIGHT TRACK  
ALTOONA  
814-942-4345

JIM'S TRAIN SHOP  
HOMER CITY  
724-479-2026  
sudsy@stargate.net

YE OLDE TRAIN & CHRISTMAS  
SHOPPE  
BOYERTOWN  
610-369-0755  
www.yoldetrain.com

TOBY TYLER'S HOBBY CENTER  
PITTSBURGH  
412-653-5030  
tobytyler111@cs.com

BUSTLETON TRAIN SHOP  
PHILADELPHIA  
215-698-7266

CHESTNUT TOYBOX  
PHILADELPHIA  
215-545-0455  
chestnuttoy@earthlink.net

THE CABOOSE  
LEIGHTON  
570-386-5352  
www.thecaboosehobbies.com  
victen@ptd.net

**SOUTH CAROLINA**  
EMERALD TRAIN & HOBBY  
GREENWOOD  
864-223-2247

**TENNESSEE**  
MODEL RAILROAD & HOBBY SHOP  
MEMPHIS  
901-384-6500  
mrhs99@earthlink.net  
www.modelrailroadandhobby.com

**TEXAS**  
HOBBY TIME  
AMARILLO  
806.352.9660  
don.l.harris.@hobby-time.com

**VIRGINIA**  
TRAIN DEPOT  
MANASSAS  
703-335-2216

NORGE STATION  
WILLIAMSBURG  
757-564-7623  
norgetrains@cs.com

NUTBUSH EXPRESS  
VICTORIA  
804-696-1902  
thenutbushexp@meckcom.net

TOY TRAIN CENTER  
RICHMOND  
804-288-4475

T S G HOBBIES  
WARRENTON  
540-347-9212  
triji@mnsinc.com  
www.mnsinc.com/triji/tsg.htm

CHESTERFIELD HOBBIES  
MIDLOTHIAN  
804-379-9091  
chsthobb@erols.com  
www.chesterfieldhobbies.com

DAVIS HOBBY SUPPLIES  
PORTSMOUTH  
757-397-1983  
ralph@davishobby.com  
www.davishobby.com

LOCUST GROVE TRAINS  
LOCUST GROVE  
540-854-8955  
lgtrains@aol.com  
www.locustgrovetrains.com

**WEST VIRGINIA**  
PATRICK'S TRAINS  
WHEELING  
304-232-0714  
trains@palstrains.com  
www.palstrains.com

**WISCONSIN**  
SOMMERFELD'S TRAINS  
BUTLER  
262-783-7797  
questions@sommerfelds.com  
www.sommerfelds.com

G B T V & TRAINS  
GREEN BAY  
920-496-9697  
rtycoon@netnet.net

GRAMPA'S TRAIN SHOP  
RICE LAKE  
715-234-2996  
grampastrainsshop@yahoo.com

THE TRAIN STORE  
WAUKESHA  
262-650-6675

HOBBY OUTLET  
FOND DU LAC  
920-924-3770  
hobby\_outlet@hotmail.com

**CANADA**  
**ONTARIO**  
CREDIT VALLEY RAILWAY COMPANY  
STREETSVILLE  
905-826-1306  
CVRCO@globalserve.net  
www.cvrco.com

TOY TRAIN WORKSHOP  
CUMBERLAND  
613-833-3125  
info@toytrainworkshop.com  
www.toytrainworkshop.com

THE TRAIN ROOM  
FERGUS  
519-787-3280





# F59 PH Diesel Locomotive Set

## OPERATOR'S MANUAL



### Compatibility

This engine will operate on any traditional O-31 Gauge track system, including M.T.H.'s RealTrax<sup>®</sup> or ScaleTrax<sup>™</sup> or traditional tubular track. It is also compatible with most standard AC transformers. (See page 19 for a complete list of compatible transformers and wiring instructions.)



Passenger Station Announcements



**PLEASE READ BEFORE USE AND SAVE**

# Table of Contents

<b>Set Up Checklist</b> .....	3
Lubrication.....	3
Checking The Battery.....	3
<b>Basic Operation</b> .....	4
Activating Features.....	4
<b>Configuring For Display</b> .....	5
<b>Proto-Sound 2.0 Operating Instructions</b> .....	6
Activating Proto-Sound 2.0 Conventional Mode Features.....	6
Passenger Station Announcements (PSA).....	7
Speed Control.....	9
Locking Locomotive Into A Direction.....	10
Reset To Factory Default.....	10
Automatic Sound Effects.....	10
<b>Maintenance</b> .....	11
Lubricating and Greasing Instructions.....	12
Cleaning The Wheels, Tires and Track.....	12
Traction Tire Replacement Instructions.....	13
Headlight Replacement Instructions.....	14
Self Charging Battery Back-Up.....	14
Troubleshooting Proto-Sound® 2.0 Problems.....	16
Transformer Compatibility and Wiring Chart.....	19
Additional Features Accessible Of DCS Remote Control System.....	20
Service & Warranty Information.....	21
Limited One-Year Warranty.....	21

**CAUTION: ELECTRICALLY OPERATED PRODUCT:**

Not recommended for children under 10 years of age. M.T.H. recommends adult supervision with children ages 10 - 16. As with all electric products, precautions should be observed during handling and use to reduce the risk of electric shock.

**WARNING:** When using electrical products, basic safety precautions should be observed, including the following: Read this manual thoroughly before using this device.

- M.T.H. recommends that all users and persons supervising use examine the hobby transformer and other electronic equipment periodically for conditions that may result in the risk of fire, electric shock, or injury to persons, such as damage to the primary cord, plug blades, housing, output jacks or other parts. In the event such conditions exist, the train set should not be used until properly repaired.
- Do not operate your layout unattended. Obstructed accessories or stalled trains may overheat, resulting in damage to your layout.
- This train set is intended for indoor use. Do not use if water is present. Serious injury or fatality may result.
- Do not operate the hobby transformer with damaged cord, plug, switches, buttons or case.

# Set Up Checklist

- Lubricate the locomotive
- Check to see whether the battery needs to be charged for full sound effects
- Apply power to run as described in the Basic Operating Section of this manual

## Lubrication

You should lubricate the engine to prevent it from squeaking. Use light household oil and follow the lubrication points marked “L” in Fig. 1. Do not over-oil. Use only a drop or two on each pivot point.

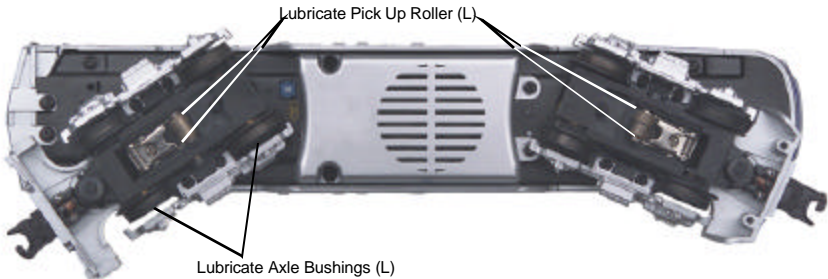

Figure 1. Lubrication Points on the Locomotive

## Checking The Battery

You may find, if your locomotive was built several months before you set it up, that the rechargeable battery has run down and needs to be charged before operating. If you notice that the sounds are garbled, test and charge the engine as described in the "Self-Charging Battery Back-Up" on page 14.

# Basic Operation

The Throttle knob controls how fast your train will travel.

Turn the throttle knob up ½-way, until the engine and caboose lights shine bright.

Put the engine into motion by pressing the Direction button on your transformer once. (hold it for approximately 1 second)

If the engine does not begin to move as soon as you firmly press the Direction button, you may not have sent enough voltage to the track to make the train move. Turn the throttle up a bit higher until the train begins to move.

## Activating Features

**Throttle** To increase or decrease track voltage, and therefore train speed, turn the throttle control knob. Turning clockwise will increase voltage and speed, while turning counterclockwise will decrease voltage and speed. The engine will maintain the speed you set after you release the throttle until you turn it again to change the voltage and speed.

**Bell** - To sound the bell, in an engine equipped with a bell firmly press and release the Bell button. To turn the bell off, press and release the Bell button again. The bell will continue to ring from the time you turn it on until you press and release the button again to turn it off.

**Horn/Whistle** - To sound the whistle, firmly press the Horn/Whistle button. The whistle will sound for as long as you continue to depress the button. It will stop when you release the button.

**Direction** Your train is programmed to start in neutral. The train will always cycle neutral-forward-neutral-reverse with each press and release of the direction button. The engine is programmed to restart in neutral each time the track voltage is turned off for 25 seconds or more.

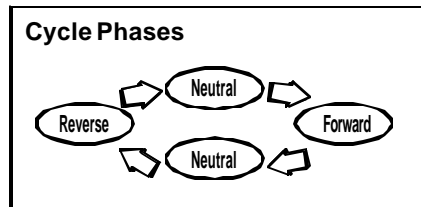

## Manual Volume Control

To adjust the volume of all sounds made by this engine, turn the master volume control knob located next to the fuel tank clockwise to increase the volume and counter-clockwise to decrease the volume.



*Figure 2: Manual Proto-Sound 2.0 Volume Adjustment*

# Proto-Sound 2.0

## Operating Instructions

This manual contains the operating instructions for Proto-Sound 2.0 in conventional mode only. Instructions for accessing DCS command mode features accompany the DCS Remote Control System equipment.

### Activating Proto-Sound 2.0 Conventional Mode Features

Proto-Sound 2.0 features are activated by sequences of Bell and Horn button pushes described below. Please read the full descriptions of each feature before using it. To use these buttons to activate features rather than to blow the horn or ring the bell, you should tap the buttons very quickly with a ½-second pause between button presses. You may need to practice your timing to make this work smoothly.

Timing Chart				
Press Horn Short & Firm	½ Sec. Pause	Press Bell Short & Firm	½ Sec. Pause	Press Bell Short & Firm
Total Time Lapse: 1 ½ Seconds				

Feature to Be Activated	Button Code:
Passenger Station Announcements	1 Bell, 2 Horns
Fire the Rear Coupler	1 Bell, 3 Horns
Fire the Front Coupler	1 Bell, 4 Horns
Speed Control On/Off	1 Horn, 2 Bells (from Neutral only)
Lock into a Direction	1 Horn, 3 Bells
Reset to Factory Defaults	1 Horn, 5 Bells (from Neutral only)

# Passenger Station Announcements (PSA)

Your engine is equipped with a sound package of passenger station announcements that you can play when you pull into a station. Each sequence described below will play as long as it is left on, randomly generating sounds, but be sure to allow approximately 30 seconds between the button pushes described below to allow the PSA sufficient time to run through each sequence.

- To cue the sound system to play the PSA, quickly but firmly tap the Bell button once followed by 2 quick taps of the Horn button while the engine is moving. Tap the buttons quickly but allow approximately 1/2 second between each press.
- Press the Direction button once to stop the engine. This will trigger the first sequence of PSA. The reverse unit is temporarily disabled so that the train will not move as you use the Direction button to trigger the sounds, and Proto-Sound 2.0 has disabled operator control over the Horn and Bell buttons until the full PSA sequence is complete.
- After waiting about 30 seconds for that sequence to run, press the Direction button again to trigger the second sequence of PSA.
- After about 30 seconds, press the Direction button again to trigger the third PSA sequence.
- Again, after allowing about 30 seconds for that sequence to run, press the Direction button one more time to trigger the fourth and final PSA sequence. The PSA will continue, and within a few seconds, the engine and bell will start and move out on its own at the current throttle setting, in the same direction it was traveling when you began the sequence. Once the bell turns off, the operator regains control of the transformer's bell and Horn buttons and can ring the bell or blow the Horn as usual.

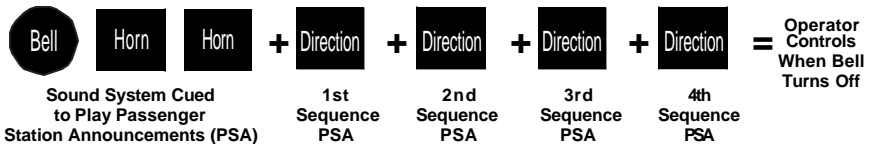

## Tips on Using PSA

- You can terminate PSA at any time by turning off power to the track for 15 seconds.
- You do not have to be in Forward to use PSA. At the conclusion of the full sequence, the train will pull away from the station in whatever direction you were going when you activated the feature.
- You can use PSA even if you are double-heading with another engine. If the second engine is not equipped with Proto-Sound 2.0, you must remember not to leave the throttle at a high voltage level once you have stopped the engine to run the PSA. Otherwise, the engine without PSA will begin vibrating on the track as its motors strain to move the train, since they cannot be automatically disabled during the PSA cycle (or if an original Proto-Sound engine, PSA are triggered differently and that engine's motor-disable feature will not be active when you run PSA in Proto-Sound 2.0).
- PSA can be triggered from Neutral. It will operate the same as if triggered while in motion except that, at the conclusion of the PSA, the engine will depart in the next direction of travel, as opposed to the direction it was traveling before entering Neutral.



# Speed Control

M.T.H. engines equipped with Proto-Sound 2.0 have speed control capabilities that allow the engine to maintain a constant speed up and down grades and around curves, much like an automobile cruise control. You can add or drop cars on the run, and the engine will maintain the speed you set.

While the engine is programmed to start with the speed control feature activated, you can opt to turn it off. This means the engine's speed will fall as it labors up a hill and increase as it travels downward. It is also affected by the addition or releasing of cars while on the run. Because the engine will run more slowly at a given throttle voltage when speed control is on than when it is off, you should adjust the throttle to a lower power level for operation with speed control off to avoid high-speed derailments. When speed control is off, the volume will drop to allow for better low voltage operation.

**To turn speed control on and off**, put the engine in neutral, then quickly tap the transformer's Horn button one time then quickly tap the Bell button two times, allowing approximately 1/2 second to lapse between each quick button press. Two horn blasts will indicate that the engine has made the change. Repeat the 1 horn, 2 bells code to return it to the other condition. You will want to do this during the initial neutral upon start-up if you ever couple this engine to another engine that is not equipped with speed control to avoid damaging the motors in either engine. Each time you shut down the engine completely, it will automatically turn speed control on.



Place  
Engine into  
Neutral



=

**Speed Control**  
**Two Horn Blasts**  
(indicates change is made)  
**Repeat to Return**  
**to Normal Condition**

# Locking Locomotive Into A Direction

You can lock your engine into a direction (forward, neutral, or reverse) so that it will not change directions. To do this, put the engine into the direction you want (or into neutral to lock it into neutral), run it at a very slow crawl (as slowly as it will move without halting), and quickly but firmly tap the Horn button once followed by three quick taps of the Bell button, allowing approximately 1/2 second to lapse between each quick button press. Two horn blasts will indicate that the engine has made the change. The engine will not change direction (including going into neutral) until you repeat the 1 horn, 3 bells code to return the engine to its normal condition, even if the engine is kept without power for extended periods of time.

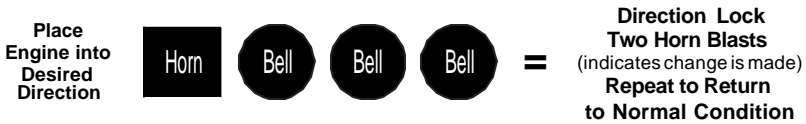

# Reset To Factory Default

To override the settings you currently have assigned to the engine and reset it to its factory defaults, while in Neutral tap the Horn button quickly once, followed by five quick taps of the Bell button, allowing approximately 1/2 second to lapse between each quick button press. Two horn blasts will indicate that the engine has made the change.

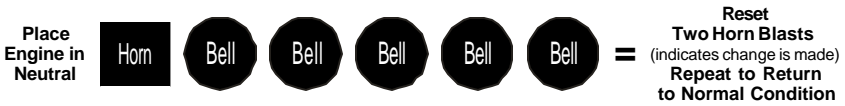

# Automatic Sound Effects

Certain Proto-Sound 2.0 sound effects automatically play in programmed conventional mode conditions:

- Squealing Brakes play any time the engine's speed decreases rapidly.
- Cab Chatter plays at random intervals when the engine idles in neutral.
- Engine Start-up and Shut-down sounds play when the engine is initially powered on or is powered off for five seconds or more.

# Maintenance

## Lubricating and Greasing Instructions

The engine should be well oiled and greased in order to run properly.

Regularly lubricate all axles and linkage components and pickup rollers to prevent squeaking. Use light household oil, such as that found in M.T.H.'s maintenance kit. Do not over oil. Use only a drop or two on each pivot point.

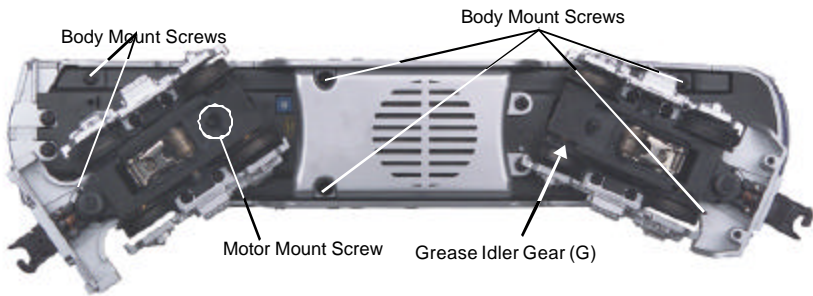

Figure 3

The locomotive's internal gearing was greased at the factory and should not need additional grease until after 50 hours of operation or one year, whichever comes first. Follow the greasing instructions below. Note that in some tightly packed engines you may need to move internal components temporarily in order to access the gears.

1. To access the gear box, remove the cab from the chassis by unscrewing the chassis screws as seen in Figure 3 and lifting the cab from the chassis.
2. Once the cab is removed, remove the trucks by unscrewing the black Phillips motor mount screw located on the underside of the drive trucks (see Fig. 4).
3. Once the motor mount screw has been removed, pull the motor away from the truck block and lightly coat the motor worm gear and bronze drive gear (in the truck block) with grease.
4. Reassemble the truck and motor, being careful not to pinch any wires between the truck block and motor mount.

5. After repeating the procedure for the other motor, reassemble the chassis and body, being careful that the wire harnesses are not caught between the chassis and body and reinstall the chassis screws.

Lubricate the outside truck block idler and drive gears with grease. Use the diagram shown in Figure 4 as a guide and add grease to the points marked with a “G.”

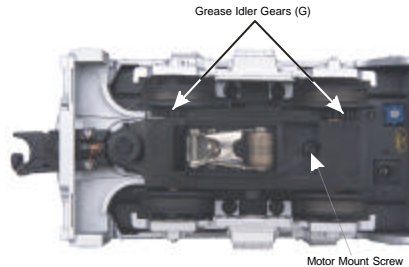

Figure 4

## Cleaning The Wheels, Tires and Track

Periodically check the locomotive wheels and pickups for dirt and buildup, which can cause poor electrical contact and traction as well as prematurely wear out the neoprene traction tires.

Periodically check the locomotive wheels and pickups for dirt and buildup, which can cause poor electrical contact and traction and prematurely wear out the neoprene traction tires. Wheels and tires can be cleaned using denatured (not rubbing) alcohol applied with a cotton swab.



To clean the track, use RailKing Track Cleaning Fluid and a clean rag or denatured (not rubbing) alcohol. Unplug the transformer and wipe the rails of the track, turning the rag frequently to ensure that you are using clean cloth on the rails. Thereafter, keep an eye on the track and clean it when it gets dirty to ensure good electrical contact and to lengthen the life of the tires.

# Traction Tire Replacement Instructions

Your locomotive is equipped with two neoprene rubber traction tires on each powered truck block. While these tires are extremely durable, you may need to replace them at some point.

First, remove the truck sides from the truck block. To do this, turn your engine upside down and remove the chassis as detailed on page 11.

Remove the trucks from the chassis and the truck sides from the trucks in order to slip the new tire over the grooved drive wheel.

Once the truck sides have been removed:

1. Make sure the old tire has been completely removed from the groove in the drive wheel, using a razor blade or small flathead screwdriver to pry away any remains.
2. Slip the new tire onto the wheel. You may find it useful to use two small flathead screwdrivers to stretch the tire over the wheel.
3. If you twist the tire while stretching it over the wheel, you will need to remove and reinstall the tire. Otherwise your engine will wobble while operating.
4. Make sure the tire is fully seated inside the groove. Use a razor blade to trim away any excess tire that will not seat inside the groove properly.
5. Reassemble in the reverse order.

Replacement parts and wick replacement instructions are available directly from the M.T.H. Parts Department (order online: [www.mth-railking.com](http://www.mth-railking.com), e-mail: [parts@mth-railking.com](mailto:parts@mth-railking.com); mail: 7020 Columbia Gateway Drive, Columbia MD 21046-1532, FAX: 410-381-6122).

# Headlight Replacement Instructions

The locomotive's headlight is controlled by a constant voltage circuit in the engine. The headlight is easy to remove and replace when it burns out. The bulb has a quick disconnect plug that attaches the bulb harness to a light circuit. Replacement bulbs are available directly from the M.T.H. Parts Department.

Follow the body removal instructions found in the Lubrication and Greasing Instructions.

Gently push down and turn to the left, pull out and replace the bulb.

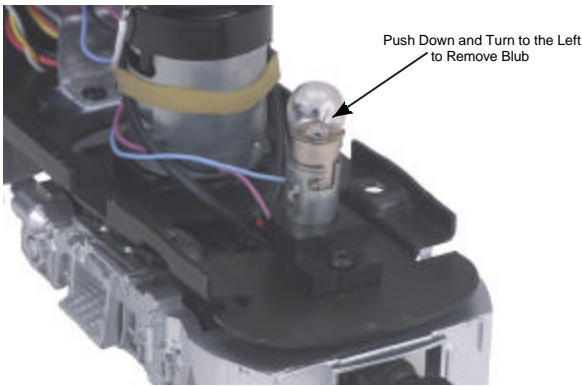

Figure 5

## Self Charging Battery Back-Up

The special NiCad 7-cell 8.4v self-charging battery recharges continuously during train operation and should last for up to five years. The battery is a dry battery that should not leak or cause any damage to your engine. Depending upon when your engine was built, it may need to be charged right out of the box. If engine sounds seem distorted or garbled at low voltages or become silent when power from the transformer is turned off, test the battery to determine whether it should be recharged or replaced.

**Test:** Put the engine in neutral and leave the track voltage at 10-12 volts (high enough for the lights to shine brightly and the engine to move steadily) for 15 minutes.

**Recharge:** If the sounds are improved at the end of the 15-minute test charge, the battery charge has run down and can be recharged. There are a number of ways you can do this:

- Leave the engine in neutral with track voltage at 10-12 volts for 6-7 hours so the battery can fully recharge (if your engine has a smoke unit, be sure it is turned off).
- Use M.T.H.'s battery recharger (sold separately) that plugs into a wall outlet and a special port under the engine to recharge the battery overnight without leaving it on the track.

**Replace:** If the sounds are not improved at the end of the 15-minute test charge, it is time to replace the battery. Available through M.T.H. Parts. A standard 9v alkaline battery can be substituted until your replacement arrives, but since alkaline batteries cannot be recharged, it will eventually wear down. Do NOT use a 6-cell 7.2v battery.

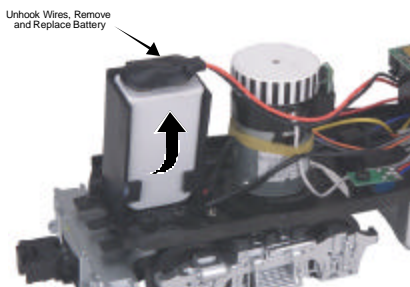

Figure 6

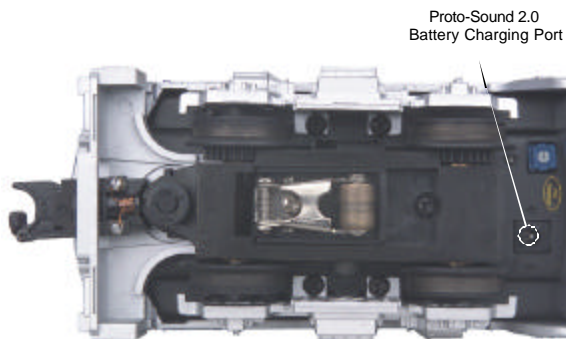

Figure 7

# Troubleshooting Proto-Sound® 2.0 Problems

Although Proto-Sound 2.0 has been designed and engineered for ease of use, you may have some questions during initial operation. The following table should answer most questions. If your problem cannot be resolved with this table, contact M.T.H. for assistance (telephone: 410-381-2580; fax: 410-423-0009; service@mth-railking.com, 7020 Columbia Gateway Drive, Columbia MD 21046-1532).

<b>Starting Up</b>	<b>Remedy</b>
When I first turn the power on, the engine will not begin to run. I have to turn the throttle off and then on again to get the engine to operate.	This is normal behavior. To prevent accidental high-speed start-ups, Proto-Sound 2.0 is programmed to start up in neutral anytime track power has been turned off for several seconds. See the "Basic Operation" section for more details.
<b>Horn</b>	<b>Remedy</b>
When I press the whistle button, the bell comes on instead.	Reverse the transformer leads.
I can't get the horn to blow when I press the whistle button.	You may be pressing the button too quickly. Try pressing the whistle button more slowly, taking approximately one full second to fully depress the button.
<b>Bell</b>	<b>Remedy</b>
When I press the whistle button, the bell sounds.	Reverse the transformer leads.
I can't get the bell to ring when I press the bell button.	You may be pressing the button too quickly. Try pressing the bell button more slowly, taking approximately one full second to fully depress the button.
The bell won't work on a separate bell button.	Check the wiring of the separate button.
<b>Coupler</b>	<b>Remedy</b>
When I try to fire the coupler, PSA starts.	You are waiting too long between whistle button presses.
The Proto-Coupler won't let the engine uncouple on the fly.	Try lubricating the coupler knuckle with a dry graphite lubricant. Do NOT use oil.



<b>C ab Chatter</b>	<b>Remedy</b>
Sometimes the Cab Chatter sounds don't play.	Cab Chatter plays only in neutral.
<b>Lock-out</b>	<b>Remedy</b>
I can't get the engine to run after I power up the transformer. It sits still with the engine sounds running.	The engine is locked into the neutral position. Follow the procedure in the "Lock into a Direction" section.
The engine won't lock into forward, neutral, or reverse.	Engine speed must be below 10 scale mph (approx. 10 volts or less in conventional mode).
<b>Volume</b>	<b>Remedy</b>
The sounds seem distorted, especially when the whistle or bell is activated.	Proto-Sound 2.0 volume is set too high. Turn the volume control knob on the bottom of the chassis counter-clockwise to reduce the volume.
<b>B attery</b>	<b>Remedy</b>
The engine will not leave the initial neutral setting	Check to be sure the battery is installed and fully charged. See the "Self-Charging Battery Back-Up" section.
I get no sounds when the engine shifts between directions.	The battery may be dead or need to be charged. See the "Self-Charging Battery Back-Up" section.
After I turn off my transformer, my engine continues to make sounds before quitting.	Proto-Sound 2.0 is designed to continue to sound for a few seconds after power to the track has been shut off.
<b>PSA</b>	<b>Remedy</b>
The PSA sounds occasionally repeat themselves.	Proto-Sound 2.0 has a built-in random number generator that randomly selects each sound clip to play. Because there are a limited number of sound clips available in each PSA sequence, it is probable that some of these sound clips will be repeated from time to time.

PSA	Remedy
Once in PSA, the engine doesn't go into reverse.	So that PSA effects can be as realistic as possible, Proto-Sound 2.0 disables the reversing unit whenever PSA is enabled. This way the engine remains still at its stop as the operator cycles through the PSA sequences.
When the PSA enters its last sequence the bell automatically comes on.	PSA is programmed to start ringing the bell at that point. After approximately 12 rings of the bell, it will automatically turn off.
When PSA is enabled, pressing the whistle and bell buttons has no effect.	Because PSA must control various effects in each sequence, Proto-Sound 2.0 takes control of these sound effects until you exit PSA.
I push the direction button but the next sound clip in the sequence does not play or the engine does not come out of PSA after fourth press of the direction button.	Each PSA clip must play for approx. 30 seconds before PSA will advance to the next step in the PSA cycle. Wait at least 30 seconds in each PSA sound clip before pressing the direction button.

# Transformer Compatibility and Wiring Chart

Proto-Sound 2.0 is designed to work with most standard AC transformers. The chart below lists the many compatible transformers. Note that many of the operational commands described in these instructions require a bell button, so if your transformer does not have its own bell button, you should consider adding one to get the full benefit of the system. In addition, the chart details how the terminals on these transformers should be attached to your layout.

Transformer Model	Center Rail	Outside Rail	Min/Max. Voltage	Power Rating	Transformer Type
MTH Z-500	Red Terminal	Black Terminal	0-18v	50-Watt	Electronic
MTH Z-750	Red Terminal	Black Terminal	0-21v	75-Watt	Electronic
MTH Z-4000	Red Terminal	Black Terminal	0-22v	390-Watt	Electronic
Lionel 1032	U	A	5-16v	90-Watt	Standard
Lionel 1032M	U	A	5-16v	90-Watt	Standard
Lionel 1033	U	A	5-16v	90-Watt	Standard
Lionel 1043	U	A	5-16v	90-Watt	Standard
Lionel 1043M	U	A	5-16v	90-Watt	Standard
Lionel 1044	U	A	5-16v	90-Watt	Standard
Lionel 1053	U	A	8-17v	60-Watt	Standard
Lionel 1063	U	A	8-17v	60-Watt	Standard
All-Trol	Left Terminal	Right Terminal	0-24v	300-Watt	Electronic
Dallee Hostler	Left Terminal	Right Terminal			Electronic
Lionel LW	A	U	8-18v	75-Watt	Standard
Lionel KW	A or B	U	6-20v	190-Watt	Standard
Lionel MW	Outside Track Terminal	Inside Track Terminal	5-16v	50V.A.	Electronic
Lionel RS-1	Red Terminal	Black Terminal	0-18v	50V.A.	Electronic
Lionel RW	U	A	9-19v	110-Watt	Standard
Lionel SW	U	A	Unknown	130-Watt	Standard
Lionel TW	U	A	8-18v	175-Watt	Standard
Lionel ZW	A,B,C or D	U	8-20v	275-Watt	Standard
Lionel Post-War Celebration Series ZW	A,B,C or D	Common	0-20v	135/190 Watt	Electronic

\* Conventional Mode Only

# Additional Features Accessible With The DCS Remote Control System

(Additional equipment required)

While conventional mode operation of a Proto-Sound 2.0 engine yields wonderfully realistic sound and several train control features, command mode operation allows the user to access a world of command functions never before accessible to O Gauge railroaders. With the addition of the DCS Remote Control System (including a DCS remote handheld and Track Interface Unit) users gain many advanced features, including:

- DCS Proto-Speed Control - Establishes desired locomotive speed in scale miles per hour increments via a thumbwheel control and allows operator to set maximum speed and acceleration/deceleration rates
- ProtoSmoke® Variable Output Control - Controls how much smoke each engine outputs and matches smoke to locomotive speed
- Locomotive Lighting Control - Controls locomotive headlights, marker and interior lights, beacon lights, ditch lights, and MARS lights
- Emergency Stop-Single button push stops all Proto-Sound 2.0 trains but does not turn off the power
- One Touch Global Mute/UnMute-Single button mutes or unmutes all DCS-controlled locomotives' user-defined actions, including sound, lights, and smoke
- Proto-Dispatch Operation-Public Address-like feature allows users to speak through locomotive speaker during operation
- Proto-Cast-Allows users to play audio recordings through locomotive speaker during operation
- Proto-Doppler Sound Effects Set Up-Users can configure locomotive for Doppler Operation, including setting distance points for Doppler start, repeat, and stop modes
- Independent Volume Control of Engine Sounds, Bell, Horn & Whistle for each Locomotive
- Control up to 50 different DCS-Equipped Locomotives at one time with multiple TIUs
- Proto-Effects™ Set Up-User can select individual Proto-Effects™ operations to be active or inactive, including cab chatter, train wreck sounds, coupler sounds, and wheel clickety-clack sounds
- Direction Control Set Up-User can set initial individual start-up direction (start in forward or reverse) for double-heading operations
- Locomotive Consist Set-up-User can determine locomotive values for consist make-ups, allowing multiple locomotives belonging to a consist to operate together

# Service & Warranty Information

## How to Get Service Under the Terms of the Limited One-Year Warranty

For warranty repair, follow the instructions below to obtain warranty service.

First, e-mail, write, call or fax an Authorized M.T.H. Service Center in your area or M.T.H. Electric Trains to obtain Repair Authorization. You can find the list of Authorized Service Centers on the M.T.H. website, [www.mth-railking.com](http://www.mth-railking.com). Authorized Service Centers are required only to make warranty repairs on items sold from that store; all other repairs may or may not be done at the store's own discretion. Otherwise, contact M.T.H. (fill out the Service Contact form in the Service Section of [www.mth-railking.com](http://www.mth-railking.com); send US mail to the address listed below; tel: 410-381-2580; fax: 410-423-0009), stating when the item was purchased and describing the problem. If you contact M.T.H., you will be given a return authorization number to assure that your merchandise will be properly handled upon its receipt.

**CAUTION:** Make sure the product is packed in its original factory packaging including its foam and plastic wrapping material so as to prevent damage to the merchandise. The shipment must be prepaid and we recommend that it be insured. *A cover letter including your name, address, daytime phone number, e-mail address (if available), Return Authorization number, a copy of your sales receipt and a full description of the problem must be included to facilitate the repairs. Please include the description regardless of whether you discussed the*

## Limited One-Year Warranty

All M.T.H. products purchased from an Authorized M.T.H. Train Merchant are covered by this warranty.

See our website at [www.mth-railking.com](http://www.mth-railking.com) or call 1-888-640-3700 to identify an Authorized M.T.H. Train Merchant near you.

M.T.H. products are warranted for one year from the date of purchase against defects in material or workmanship, excluding wear items such as light bulbs, pick-up rollers, batteries, smoke unit wicks, and traction tires. We will repair or replace (at our option) the defective part without charge for the parts or labor, if the item is returned to an Authorized M.T.H. Service Center or M.T.H. Electric Trains within one year of the original date of purchase. This warranty does not cover damages caused by improper care, handling, or use. Transportation costs incurred by the customer are not covered under this warranty.

Items sent for repair must be accompanied by a return authorization number, a description of the problem, and a copy of the original sales receipt from an Authorized M.T.H. Train Merchant, which gives the date of purchase. If you are sending the item to M.T.H., fill out the Service Contact form in the Service Section of [www.mth-railking.com](http://www.mth-railking.com); send US mail to the address listed below; call 410-381-2580, or fax 410-423-0009 to obtain a return authorization number. If you are sending this product to an Authorized Service Center, contact that Center for their return authorization.

This warranty gives you specific legal rights, and you may have other rights that vary from state to state.

Service Department  
M.T.H. Electric Trains  
7020 Columbia Gateway Drive  
Columbia MD 21046-1532



**MTH**  
ELECTRIC TRAINS<sup>®</sup>

**AUTHORIZED SERVICE CENTER**

**7020 Columbia Gateway Dr. - Columbia, MD 21046**  
**Information: 410-381-2580 Fax: 410-381-6122**  
[www.mth-railking.com](http://www.mth-railking.com)

## PARTICIPATING RETAILER LIST

### ALABAMA

SOUTHERLAND STATION  
 HUNTSVILLE  
 256-533-4720  
[railway@bellsouth.net](http://railway@bellsouth.net)

### ARIZONA

ARIZONA TRAIN DEPOT  
 MESA  
 480-833-9486  
[sales@arizonatraindepot.com](mailto:sales@arizonatraindepot.com)  
[www.arizonatraindepot.com/](http://www.arizonatraindepot.com/)

### CALIFORNIA

DOLLHOUSES, TRAINS & MORE  
 NOVATO  
 415-883-0388  
[kbecker@cmc.net](mailto:kbecker@cmc.net)

### TIN PLATE JUNCTION

OAKLAND  
 510-444-4780  
[TOYTRAINS@email.msn.com](mailto:TOYTRAINS@email.msn.com)

### COLORADO

MIZELL TRAINS Inc  
 WESTMINSTER  
 303-429-4811  
[mizelltrains@cs.com](mailto:mizelltrains@cs.com)  
[www.mizelltrains.com](http://www.mizelltrains.com)

### CONNECTICUT

SHELTON RAILROAD SYSTEMS  
 SHELTON  
 203-924-8761  
[adriani@clearlight.com](mailto:adriani@clearlight.com)  
 NEW ENGLAND HOBBY SUPPLY  
 MANCHESTER  
 860-646-0610  
[bobbell@nehobby.com](mailto:bobbell@nehobby.com)

### DELAWARE

K R R B MODEL TRAINS INC.  
 NEWARK  
 302-292-2779  
[info@krbb.com](mailto:info@krbb.com)  
[www.krbb.com](http://www.krbb.com)

### FLORIDA

DEPOT HOBBY SHOP  
 LAKE WORTH  
 561-585-1982  
[jimmy11982@aol.com](mailto:jimmy11982@aol.com)  
[www.depothobbies.com](http://www.depothobbies.com)

### COLONIAL PHOTO & HOBBY

ORLANDO  
 407-841-1485  
[trains@colonialphotoandhobby.com](mailto:trains@colonialphotoandhobby.com)

### WARRICK CUSTOM HOBBIES

PLANTATION  
 954-370-0708  
[info@warrickcustomhobbies.com](mailto:info@warrickcustomhobbies.com)  
[www.warrickcustomhobbies.com](http://www.warrickcustomhobbies.com)

### FRANK'S TRAINS & HOBBIES INC.

OLDSMAR  
 813-855-1041  
[FTH@allhobbies.com](mailto:FTH@allhobbies.com)  
[www.allhobbies.com](http://www.allhobbies.com)

### READY TO ROLL

MIAMI  
 305-688-8868  
[rttrains@aol.com](mailto:rttrains@aol.com)  
[www.readytorolltrains.com](http://www.readytorolltrains.com)

### ILLINOIS

BIKE & CHOO CHOO CONNECTION  
 SCHAUMBURG  
 847-882-7728  
[trainconnection@aol.com](mailto:trainconnection@aol.com)

### INDIANA

Y. O. R. K. TRAINS  
 MUNSTER  
 219-838-9999  
[yorktrains@aol.com](mailto:yorktrains@aol.com)

### SAMUELSON'S TRAIN SHOP

VALPARAISO  
 219-462-2708

### LOUISIANA

AMERICA'S TRAIN YARD  
 BATON ROUGE  
 225-926-5592

### MAINE

WHEELS, WINGS & THINGS  
 LUDLOW  
 207-532-6277  
[irc44@javanet.com](mailto:irc44@javanet.com)

### MARYLAND

ENGINE HOUSE HOBBIES  
 GAITHERSBURG  
 301-590-0816  
[lucciecerise@aol.com](mailto:lucciecerise@aol.com)

### J & B TRAINS

HAGERSTOWN  
 240-420-4930

### HOBBYTOWN USA

FREDERICK  
 301-694-7395

### PURKEY'S TOY TRAINS

SYKESVILLE  
 410-549-6061  
[wiley@oldmainline.com](mailto:wiley@oldmainline.com)

### THE TRAIN ROOM

HAGERSTOWN  
 301-745-6681

### MASSACHUSETTS

NORTHEAST TRAINS  
 PEABODY  
 978-532-1615  
[www.netrains.com](http://www.netrains.com)

### MICHIGAN

BRASSEUR ELECTRIC TRAINS INC.  
 SAGINAW  
 517-793-4753  
[bob@traindoctor.com](mailto:bob@traindoctor.com)  
[www.traindoctor.com](http://www.traindoctor.com)

**MISSOURI**

SWITCH STAND  
 SAINT LOUIS  
 314-781-4458  
 r41877@earthlink.com

**MARK TWAIN HOBBY CENTER**

ST. CHARLES  
 636-946-2816  
 webmaster@hobby1.com  
 www.hobby1.com

**NEW HAMPSHIRE**

TREASUREDTOYS  
 SALEM  
 603-898-7224  
 ttoys@treasured-toys.com  
 www.treasured-toys.com

**RAILROAD SPECIALTIES**

HUDSON  
 603-882-5566  
 crew@electric-trains.com  
 www.electric-trains.com

**NEW JERSEY**

TRAINS & THINGS  
 TRENTON  
 609-883-8790  
 trainsanthings@aol.com

**GRAND CENTRAL STATION**

KEARNY  
 201-955-6200  
 228gene@gateway.com

**HOBBYMASTERS, INC**

RED BANK  
 732-842-6020  
 hobbymasters@hobbymasters.com

**HOLLY BEACH TRAIN DEPOT**

WILDWOOD  
 609-522-2379  
 larry@pro-usa.net

**COAST TRAINS AND COLLECTIBLES**

WALL  
 732-556-9005  
 coasttrain@aol.com  
 www.coasttrains.com

**J & B TRAINS, INC.**

MAPLE SHADE  
 856-414-0092  
 BASE1130@aol.com

**HOBBY SHOP**

MATAWAN  
 732-583-0505  
 hobbyshopnj.com

**ATLANTIC RAILS**

HAMMONTON  
 609-567-8490  
 bobcap@pics.com  
 www.atlanticrails.com

**COUNTRY AND STUFF**

ANDOVER  
 973-786-7086  
 stuff@crystal.palace.net

**RIDGEFIELD HOBBY**

RIDGEFIELD  
 201-943-2636

**COLUMBUS TRAIN STATION**

COLUMBUS  
 609-518-1800

**NEW YORK**

AURORA RAILS & HOBBIES  
 EAST AURORA  
 716-652-5718  
 rk82141@aol.com

**AMERICANA STORE**

TIVOLI  
 845-757-4246  
 mthdepot@valstar.net

**NASSAU HOBBY CENTER, INC.**

FREEPORT  
 516-378-9594  
 Charlienassau@aol.com

**KROSS HARDWARE**

WEST BABYLON  
 631-669-3069  
 1989@aol.com

**CITY DEPOT, INC.**

NEW HAMPTON  
 845-374-3010  
 citydepot@frontiernet.net  
 www.citydepot.com

**NORTH CAROLINA**

DRY BRIDGE STATION  
 MOUNT AIRY  
 336-786-9811  
 mikek@drybridgestation.com  
 www.drybridgestation.com

**THE FREIGHT YARD**

SMITHFIELD  
 919-934-6229  
 disbissette@aol.com

**TRAINS LTD.**

CHARLOTTE  
 704-566-9070  
 modelrns@bellsouth.net  
 www.trainstld.com

**THE ROUNDHOUSE & BACKSHOP**

CARY  
 919-465-0810

**OHIO**

DIXIE UNION STATION  
 MASON  
 513-459-0460  
 rockylane@core.net  
 www.dixieunionstation.com

**RICK'S TOY TRAINS**

TOLEDO  
 419-478-0171

**T & K HOBBY SHOP**

BRIDGEPORT  
 740-633-6607  
 salea@tkhobbies.com  
 www.tkhobbies.com

**TRAINS-N- THINGS**

CANTON  
 330-499-1666  
 trains@ssnet.com

**PARMA HOBBY**

CLEVELAND  
 216-741-6440  
 info@parmahobby.com

**GLEN'S TRAIN SHOP**

AKRON  
 330-253-6527

**E & S TRAINS**

AKRON  
 330-745-0785

**GRAND PACIFIC JUNCTION**

OLMSTEAD FALLS  
 440-235-4777  
 gpjmrr@juno.com  
 HUDSON TOY, TRAIN & HOBBY  
 HUDSON  
 330-653-2997  
 epickers@aol.com

**DAVIS ELECTRONICS**

MILFORD  
 513-831-6425  
 davistrains@fuse.net  
 www.davistrains.com

**SANDY'S HOBBY'S & COLLECTIBLES**

ELYRIA  
 440-365-9999  
 sandyshobb@aol.com

**ERIE RAILWAY DEPOT**

TROY  
 937-440-9972  
 orville@gte.net

**CLEARVIEW TRAIN & HOBBY**

LORAIN  
 440-277-4488  
 klogar@erienet.net  
 www.clearviewtrainandhobby.com

**PENNSYLVANIA**

FAIRCHANCE PHARMACY  
 FAIRCHANCE  
 724-564-7817  
 mhdealer@aol.com  
 www.hhs.net/fairchance

THE STATION  
NEW CUMBERLAND  
717-774-7096  
station@paonline.com  
BUSSINGER TRAINS  
AMBLER  
215-628-2366  
choochoos@icdc.com  
www.icdc.com/~btrains

CHARLEROI SWEEPER CENTER  
CHARLEROI  
724-483-3397

AMERICAN HOBBY CENTER  
ALIQUIPPA  
724-378-3930  
american@icubed.com

CRANBERRY HOBBY DEPOT  
CRANBERRY TWP  
724-776-3640  
JAdams6113@aol.com

ALLENTOWN TOY TRAIN SERVICE  
ALLENTOWN  
610-821-0740

ON THE RIGHT TRACK  
ALTOONA  
814-942-4345

JIM'S TRAIN SHOP  
HOMER CITY  
724-479-2026  
sudsy@stargate.net

YE OLDE TRAIN & CHRISTMAS  
SHOPPE  
BOYERTOWN  
610-369-0755  
www.yoldetrain.com

TOBY TYLER'S HOBBY CENTER  
PITTSBURGH  
412-653-5030  
tobytyler111@cs.com

BUSTLETON TRAIN SHOP  
PHILADELPHIA  
215-698-7266

CHESTNUT TOYBOX  
PHILADELPHIA  
215-545-0455  
chestnuttoy@earthlink.net

THE CABOOSE  
LEIGHTON  
570-386-5352  
www.thecaboosehobbies.com  
victen@ptd.net

SOUTH CAROLINA  
EMERALD TRAIN & HOBBY  
GREENWOOD  
864-223-2247

TENNESSEE  
MODEL RAILROAD & HOBBY SHOP  
MEMPHIS  
901-384-6500  
mrhs99@earthlink.net  
www.modelrailroadandhobby.com

TEXAS  
HOBBY TIME  
AMARILLO  
806.352.9660  
don.l.harris.@hobby-time.com

VIRGINIA  
TRAIN DEPOT  
MANASSAS  
703-335-2216

NORGE STATION  
WILLIAMSBURG  
757-564-7623  
norgetrains@cs.com

NUTBUSH EXPRESS  
VICTORIA  
804-696-1902  
thenutbushexp@meckcom.net

TOY TRAIN CENTER  
RICHMOND  
804-288-4475

T S G HOBBIES  
WARRENTON  
540-347-9212  
tripl@mnsinc.com  
www.mnsinc.com/tripi/tsg.htm

CHESTERFIELD HOBBIES  
MIDLOTHIAN  
804-379-9091  
chsthobb@erols.com  
www.chesterfieldhobbies.com

DAVIS HOBBY SUPPLIES  
PORTSMOUTH  
757-397-1983  
ralph@davishobby.com  
www.davishobby.com

LOCUST GROVE TRAINS  
LOCUST GROVE  
540-854-8955  
lgtrains@aol.com  
www.locustgrovetrains.com

WEST VIRGINIA  
PATRICK'S TRAINS  
WHEELING  
304-232-0714  
trains@palstrains.com  
www.palstrains.com

WISCONSIN  
SOMMERFELD'S TRAINS  
BUTLER  
262-783-7797  
questions@sommerfelds.com  
www.sommerfelds.com

G B T V & TRAINS  
GREEN BAY  
920-496-9697  
rtycoon@netnet.net

GRAMPA'S TRAIN SHOP  
RICE LAKE  
715-234-2996  
grampastrainshop@yahoo.com

THE TRAIN STORE  
WAUKESHA  
262-650-6675

HOBBY OUTLET  
FOND DU LAC  
920-924-3770  
hobby\_outlet@hotmail.com

CANADA  
ONTARIO  
CREDIT VALLEY RAILWAY COMPANY  
STREETSVILLE  
905-826-1306  
CVRCO@globalserve.net  
www.cvrco.com

TOY TRAIN WORKSHOP  
CUMBERLAND  
613-833-3125  
info@toytrainworkshop.com  
www.toytrainworkshop.com

THE TRAIN ROOM  
FERGUS  
519-787-3280