



Premier Z-6 4-6-6-4 Challenger

OPERATOR'S MANUAL

Compatibility

This engine is available in 2-rail and 3-rail versions and will operate on any traditional O-72 Gauge track system (3-rail) or any 40" radius 2-rail track system. It is also compatible with most standard AC and DC transformers. (See pages 25 & 26 for a complete list of compatible transformers and wiring instructions.



Freight Yard Sound



PLEASE READ BEFORE USE AND SAVE

Table of Contents

Configuring Locomotive for 2-Rail or 3-Rail Operation	3
Installing/Removing 3-Rail Pickup Rollers.....	3
Ensuring Proper Power to Track Polarity.....	3
Changing Track Polarity Inside the Locomotive.....	4
Set Up Checklist	5
Lubrication.....	5
Priming The Smoke Unit.....	5
Wireless Drawbar.....	6
Checking The Battery.....	6
Basic Operation	7
Activating Features.....	7
Manual Volume Control.....	8
Proto-Sound 2.0 Operating Instructions	9
Activating Proto-Sound 2.0 Conventional Mode Features.....	9
Freight Station Announcements(FSA).....	10
Proto-Coupler® Operation.....	11
Speed Control.....	12
Locking Locomotive Into A Direction.....	13
Reset To Factory Default.....	13
Automatic Sound Effects.....	13
Maintenance	14
Lubricating and Greasing Instructions.....	14
Cleaning The Wheels, Tires and Track.....	15
Traction Tire Replacement Instructions.....	16
Headlight Replacement Instructions.....	16
Self Charging Battery Back Up.....	18
ProtoSmoke® Unit Operation.....	20
Troubleshooting Proto-Sound® 2.0 Problems.....	22
Transformer Compatibility and Wiring Chart.....	25
DC Power Pack Chart.....	26
Additional Features Accessible Of DCS Remote Control System.....	27
Service & Warranty Information.....	28
Limited One-Year Warranty.....	28

CAUTION: ELECTRICALLY OPERATED PRODUCT:

Not recommended for children under 10 years of age. M.T.H. recommends adult supervision with children ages 10 - 16. As with all electric products, precautions should be observed during handling and use to reduce the risk of electric shock.

WARNING: When using electrical products, basic safety precautions should be observed, including the following:
Read this manual thoroughly before using this device.

- M.T.H. recommends that all users and persons supervising use examine the hobby transformer and other electronic equipment periodically for conditions that may result in the risk of fire, electric shock, or injury to persons, such as damage to the primary cord, plug blades, housing, output jacks or other parts. In the event such conditions exist, the train set should not be used until properly repaired.
- Do not operate your layout unattended. Obstructed accessories or stalled trains may overheat, resulting in damage to your layout.
- This train set is intended for indoor use. Do not use if water is present. Serious injury or fatality may result.
- Do not operate the hobby transformer with damaged cord, plug, switches, buttons or case.

Configuring Locomotive for 2-Rail or 3-Rail Operation

Installing/Removing 3-Rail Pickup Rollers

Both 2-Rail and 3-Rail versions of this locomotive can be configured to operate on either 2-rail or 3-rail track by removing or adding the center rail pickups. 3-rail track operation requires the pickups, 2-rail track operation does not. The pickups are factory installed on 3-rail versions and packaged separately in the locomotive box for 2-rail versions. Each pickup roller installs with a single phillips screw.

Configuring for 2-Rail or 3-Rail Power Input

Once you have configured the engine for 2-rail or 3-rail operation, you must manually select the power input switch located on the bottom of the tender for 2-rail or 3-rail operation as seen in Figure 1.

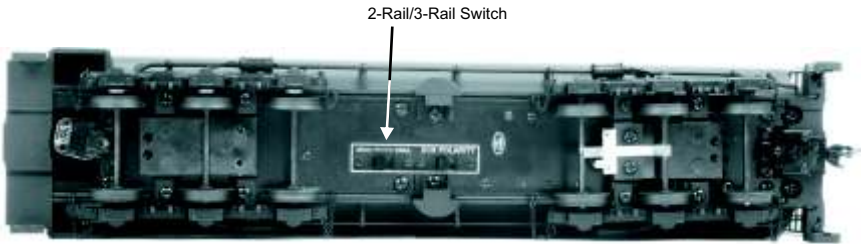

Figure 1

Ensuring Proper Power to Track Polarity

For 2-rail DCS operation, it is important that the polarity from the transformer to the engine is properly configured. Correct polarity can be accomplished by ensuring that the wiring from the TIU to the track and orientation of the locomotive when sitting on the track follows the illustration in Figure 2.

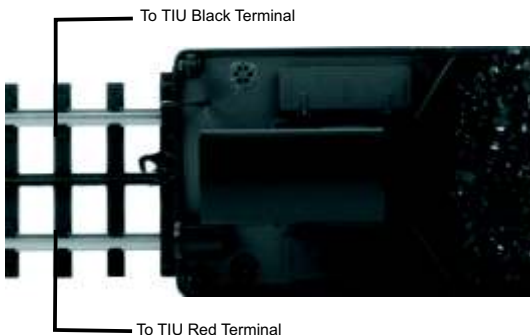

Figure 2

Changing Track Polarity Inside the Locomotive

Failing to properly configure the polarity will result in the locomotive starting in reverse instead of forward or not receiving the DCS signal. Should this occur, it is not necessary to swap the wires from the transformer to the track or reverse the locomotive's orientation on the track itself. Instead, simply slide the polarity switch located on the tender as seen in Figure 3.

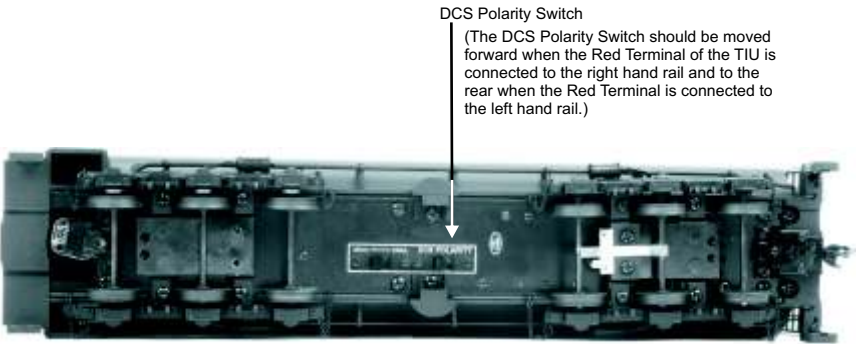

Figure 3

Set Up Checklist

Lubricate the locomotive

Prime the smoke unit

Check to see whether the battery needs to be charged for full sound effects

Apply power to run as described in the Basic Operating Section of this manual

Lubrication

You should lubricate the engine to prevent it from squeaking. Use light household oil and follow the lubrication points marked “L” in Fig. 4. Do not over-oil. Use only a drop or two on each pivot point.

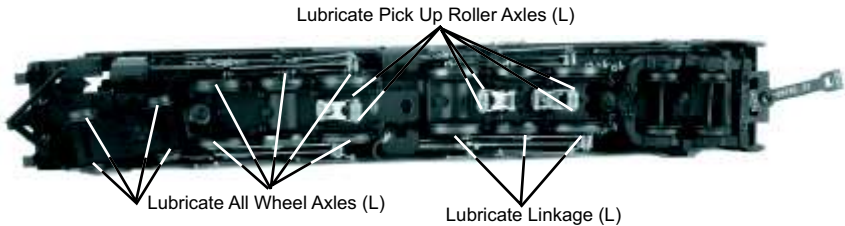
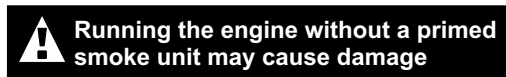

Figure 4. Lubrication Points on the Locomotive

Priming the Smoke Unit

When preparing to run this engine, add 15-20 drops of smoke fluid through the smokestack. We recommend M.T.H. ProtoSmoke, Seuthe, LGB, or LVTS fluids. Do not overfill the unit or the fluid may leak out and coat the interior engine components.

If you choose not to add the fluid (or have already added the fluid but choose to run smoke-free), turn off the smoke unit switch



Smoke Unit ON/OFF Switch



Figure 5: Smoke Unit Switch Location

Placing the Engine on Track

Your Baldwin type Challenger is equipped with a tetherless drawbar. There is no unsightly cable or box showing between the engine and tender to detract from the appearance of the model. The electrical connections pass through conductors within the drawbar, so it is important that the connector be properly inserted. The connector is fixed to the rear end of the drawbar. The mating connector is attached to a swivel connection on the front of the tender frame. The drawbar is connected to the engine chassis with a screw and should not need any attention.

In order to mate the connectors of the drawbar and the tender, place the engine and tender on the track. Then position the tender over the drawbar and insert the drawbar pin into the hole in the drawbar. Now grasp the tender with both hands as shown in Fig.6A and place a finger on each side of the drawbar near the connector. With your fingers on the drawbar, push the drawbar connector up into place. The connector will make a slight click when the connector is properly seated.



Figure 6A



Figure 6B

To disconnect the engine and tender apply downward until the connector separates.

The drawbar is able to withstand a 90 twist, such as might be experienced in a derailment and turnover of the engine or the tender.

If the drawbar connector is not properly seated when power is applied to the engine, you may some of the following malfunctions.

- The lights do not light or only some lights light.
- The smoke unit does not function
- The engine will not move when the reverse unit is cycled.

If this happens, turn off the track power and make sure that the drawbar connector is properly connected. Then reapply the track power.

Basic Operation

The Throttle knob controls how fast your train will travel. Turn the throttle knob up ½-way, until the engine and caboose lights shine bright. Put the engine into motion by pressing the Direction button on your transformer once. (hold it for approximately 1 second)

If the engine does not begin to move as soon as you firmly press the Direction button, you may not have sent enough voltage to the track to make the train move. Turn the throttle up a bit higher until the train begins to move.

Activating Features

Throttle To increase or decrease track voltage, and therefore train speed, turn the throttle control knob. Turning clockwise will increase voltage and speed, while turning counterclockwise will decrease voltage and speed. The engine will maintain the speed you set after you release the throttle until you turn it again to change the voltage and speed.

Bell - To sound the bell, in an engine equipped with a bell firmly press and release the Bell button. To turn the bell off, press and release the Bell button again. The bell will continue to ring from the time you turn it on until you press and release the button again to turn it off.

Horn/Whistle - To sound the whistle, firmly press the Horn/Whistle button. The whistle will sound for as long as you continue to depress the button. It will stop when you release the button.

Direction Your train is programmed to start in neutral. The train will always cycle neutral-forward-neutral-reverse with each press and release of the direction button. The engine is programmed to restart in neutral each time the track voltage is turned off for 25 seconds or more.

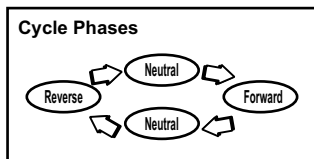

Manual Volume Control

To adjust the volume of all sounds made by this engine, turn the master volume control knob, located under the water hatch on the tender, clockwise to increase the volume and counter-clockwise to decrease the volume.



Figure 7: Manually Adjusting the Volume

Proto-Sound 2.0 Operating Instructions

This manual contains the operating instructions for Proto-Sound 2.0 in conventional mode only. Instructions for accessing DCS command mode features accompany the DCS Remote Control System equipment.

Activating Proto-Sound 2.0 Conventional Mode Features

Proto-Sound 2.0 features are activated by sequences of Bell and Horn button pushes described below. Please read the full descriptions of each feature before using it. To use these buttons to activate features rather than to blow the horn or ring the bell, you should tap the buttons very quickly with a 1/2-second pause between button presses. You may need to practice your timing to make this work smoothly.

Timing Chart				
Press Horn Short & Firm	1/2 Sec. Pause	Press Bell Short & Firm	1/2 Sec. Pause	Press Bell Short & Firm
Total Time Lapse: 1 1/2 Seconds				

Feature to Be Activated:	Button Code:
Freight Yard Sounds	1 Bell, 2 Whistle/Horn
Fire the Rear Coupler	1 Bell, 3 Whistle/Horn
Fire the Front Coupler	1 Bell, 4 Whistle/Horn
Speed Control On/Off	1 Whistle/Horn, 2 Bells (From Neutral Only)
Lock into a Direction/Unlock	1 Whistle/Horn, 3 Bells
Reset to Factory Defaults	1 Whistle/Horn, 5 Bells (From Neutral Only)

Freight Yard Sounds (FYS)

Your engine is equipped with a sound package of either freight yard or passenger station sounds that you can play. **Each sequence described below will play as long as it is left on, randomly generating sounds, but be sure to allow approximately 30 seconds between the button pushes described below to allow the FYS sufficient time to run through each sequence.**

- To cue the sound system to play the FYS, quickly but firmly tap the Bell button once followed by 2 quick taps of the Horn/Whistle button while the engine is moving. Tap the buttons quickly but allow approximately ½ second between each press.
- Press the Direction button once to stop the engine. This will trigger the first sequence of FYS. The reverse unit is temporarily disabled so that the train will not move as you use the Direction button to trigger the sounds, and Proto-Sound 2.0 has disabled operator control over the Horn/Whistle and Bell buttons until the full FYS sequence is complete.
- After waiting about 30 seconds for that sequence to run, press the Direction button again to trigger the second sequence of FYS
- After about 30 seconds, press the Direction button again to trigger the third FYS sequence.
- Again, after allowing about 30 seconds for that sequence to run, press the Direction FYS will continue, and within a few seconds, the engine will start and move out on its own at the current throttle setting, in the same direction it was traveling when you began the sequence. Once the bell turns off, the operator regains control of the transformer's Bell and Horn/Whistle buttons and can ring the bell or blow the horn/whistle as usual.

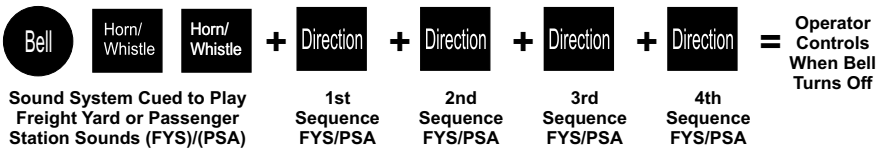

Tips on Using FYS

- You can terminate FYS at any time by turning off power to the track for 15 seconds.
- You do not have to be in Forward to use FYS. At the conclusion of the full sequence, the train will pull away from the station in whatever direction you were going when you activated the feature.
- You can use FYS even if you are double-heading with another engine. If the second engine is not equipped with Proto-Sound 2.0, you must remember not to leave the throttle at a high voltage level once you have stopped the engine to run the FYS. Otherwise, the engine without FYS will begin vibrating on the track as its motors strain to move the train, since they cannot be automatically disabled during the FYS cycle (or if an original Proto-Sound engine, FYS are triggered differently and that engine's motor-disable feature will not be active when you run FYS in Proto-Sound 2.0).
- FYS can be triggered from Neutral. It will operate the same as if triggered while in motion except that, at the conclusion of the FYS, the engine will depart in the next direction of travel, as opposed to the direction it was traveling before entering Neutral.

Proto-Coupler[®] Operation

This locomotive is equipped with one or more coil-wound Proto-Couplers for remote uncoupling action. Because Proto-Couplers are controlled through the Proto-Sound 2.0 microprocessor, they do not require an uncoupling track section or modification to your layout to function. You can fire a coupler from neutral or while in motion. Use the code shown below (and in the chart on page 7) to fire the coupler(s).

Rear Coupler:

To fire the rear coupler, quickly tap the Bell button once followed by three quick taps of the Horn/Whistle button, allowing approximately 1/2 second to lapse between each quick button press. The sound of the liftbar and air line depletion will play, and the knuckle will be released.



Front Coupler:

To fire the front coupler (if your engine has one), quickly tap the Bell button once followed by four quick taps of the Horn/Whistle button, allowing approximately 1/2 second to lapse between each quick button press. The sound of the liftbar and air line depletion will play, and the knuckle will be released.



Speed Control:

M.T.H. engines equipped with Proto-Sound 2.0 have speed control capabilities that allow the engine to maintain a constant speed up and down grades and around curves, much like an automobile cruise control. You can add or drop cars on the run, and the engine will maintain the speed you set.

While the engine is programmed to start with the speed control feature activated, you can opt to turn it off. This means the engine's speed will fall as it labors up a hill and increase as it travels downward. It is also affected by the addition or releasing of cars while on the run. Because the engine will run more slowly at a given throttle voltage when speed control is on than when it is off, you should adjust the throttle to a lower power level for operation with speed control off to avoid high-speed derailments. When speed control is off, the volume will drop to allow for better low voltage operation.

To turn speed control on and off, put the engine in neutral, then quickly tap the transformer's horn/whistle button one time then quickly tap the Bell button two times, allowing approximately 1/2 second to lapse between each quick button press. Repeat the 1 horn/whistle, 2 bells code to return it to the other condition. You will want to do this during the initial neutral upon start-up if you ever couple this engine to another engine that is not equipped with speed control to avoid damaging the motors in either engine. Each time you shut down the engine completely, it will automatically turn speed control on.

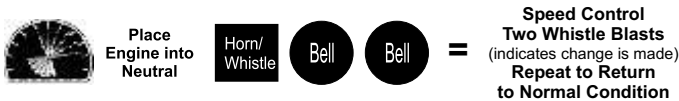

Lock into a Direction:

You can lock your engine into a direction (forward, neutral, or reverse) so that it will not change directions. To do this, put the engine into the direction you want (or into neutral to lock it into neutral), run it at a very slow crawl (as slowly as it will move without halting), and quickly but firmly tap the Horn/Whistle button once followed by three quick taps of the Bell button, allowing approximately 1/2 second to lapse between each quick button press. Two horn/whistle blasts will indicate that the engine has made the change. The engine will not change direction (including going into neutral) until you repeat the 1 horn/whistle, 3 bells code to return the engine to its normal condition, even if the engine is kept without power for extended periods of time.

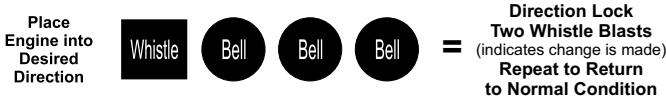

Reset to Factory Defaults:

To override the settings you currently have assigned to the engine and reset it to its factory defaults, while in Neutral tap the Horn/Whistle button quickly once, followed by five quick taps of the Bell button, allowing approximately 1/2 second to lapse between each quick button press. Two horn/whistle blasts will indicate that the engine has made the change.



Automatic Sounds:

Certain Proto-Sound 2.0 sound effects automatically play in programmed conventional mode conditions:

- **Squealing Brakes** play any time the engine's speed decreases rapidly.
- **Cab Chatter** plays at random intervals when the engine idles in neutral.
- **Engine Start-up and Shut-down** sounds play when the engine is initially powered on or is powered off for five seconds or more.

Maintenance

Lubricating and Greasing Instructions

The engine should be well oiled and greased in order to run properly.



You should regularly lubricate all side rods, linkage components and pickup rollers to prevent them from squeaking. Use light household oil and follow the lubrication points marked “L” shown below. Do not over-oil. Use only a drop or two on each pivot point.

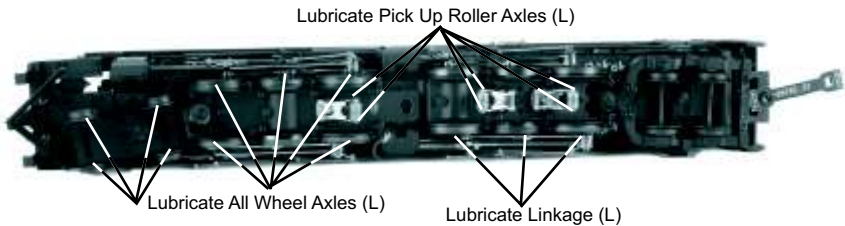

Figure 8: Removing the Body

The locomotive’s internal gearing was greased at the factory and should not need additional grease until after 50 hours of operation or one year, whichever comes first. To access the gear box and axles, do the following:

1. Turn the engine upside down.
2. Remove the Phillips screws (marked “GREASE”) located at each set of wheels and under pick up rollers (Fig. 8).
3. Use a grease tube dispenser to put a small amount (approx. 1-2 ml.) of lithium-based grease into the screw holes.
4. Replace the screws.

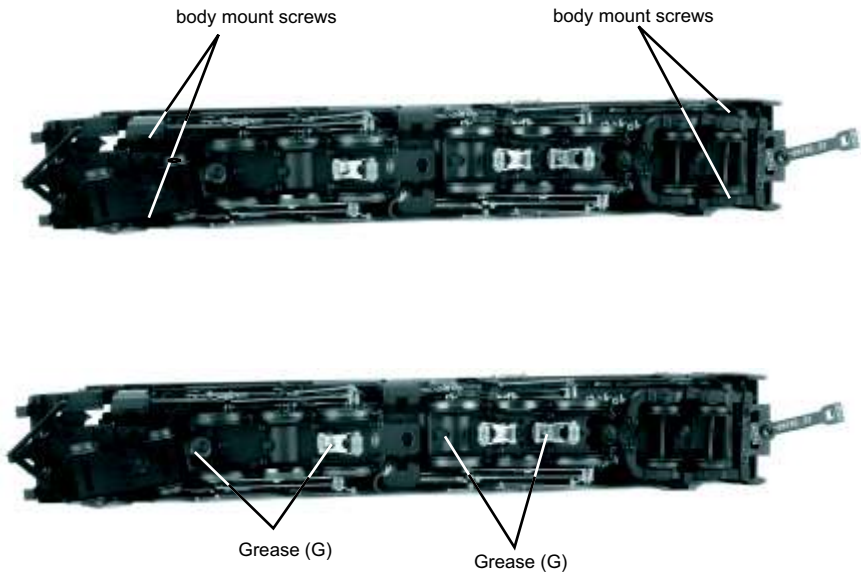

Figure 9: Removing the Body and Lubricating the grease points

You should also grease the leading and trailing locomotive truck tongues to enhance their ability to slide on the chassis. Follow the grease points shown on Fig. 9.

Cleaning the Wheels, Tire, Track

Periodically check the locomotive wheels and pickups for dirt and buildup, which can cause poor electrical contact and traction as well as prematurely wear out the neoprene traction tires.

Wheels and tires can be cleaned using denatured (not rubbing) alcohol applied with a cotton swab.



Traction Tire Replacement

Your locomotive is equipped with two neoprene rubber traction tires on the rear set of flanged drivers. While these tires are extremely durable, you may need to replace them at some point.

1. Remove the side rods from the wheels in order to slip the new tire over the grooved drive wheel. Make sure to note the position of all rods before removing.
2. Make sure the old tire has been completely removed from the groove in the drive wheel, using a razor blade or small flathead screwdriver to pry away any remains.
3. Slip the new tire onto the wheel. You may find it useful to use two small flathead screwdrivers to stretch the tire over the wheel.
4. If you twist the tire while stretching it over the wheel, you will need to remove and reinstall the tire. Otherwise your engine will wobble while operating.
5. Make sure the tire is fully seated inside the groove. Use a razor blade to trim away any excess tire that doesn't seat itself inside the groove properly.
6. Reinstall the side rods in the same positions as noted. Failure to align rods may cause binding or damage to the drive system.

One set of replacement tires is packaged with your model. Additional sets are available directly from the M.T.H. Parts Department (phone: 410-381-2580; e-mail: parts@mth-railking.com; mail: 7020 Columbia Gateway Drive, Columbia MD 21046-1532).

Headlight Replacement Instructions

The locomotive's lights are controlled by a constant voltage circuit in the engine. They are easy to remove and replace when they burn out. See the diagrams and directions below for instructions on accessing and replacing the light bulbs in this locomotive.

You can obtain replacement bulbs directly from the M.T.H. Parts Department (order online: www.mth-railking.com, e-mail: parts@mth-railking.com; mail: 7020 Columbia Gateway Drive, Columbia MD 21046-1532, FAX: 410-381-6122).

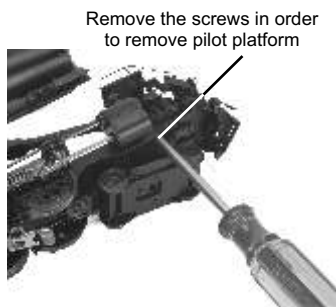

Figure 10

To Replace Headlights:

1. Remove the screw attaching the leading truck anchor bar to the pilot.
2. Remove the 2 screws that attach the pilot to the chassis.
3. Gently pull the pilot away from the chassis and unplug the connector for the headlight
4. Remove the light bulb from the headlight shell by sliding the grommet from the groove and pull the light bulb from the headlight shell.
5. Reassemble the parts in the reverse order that they were removed.
6. Be careful not pinch any wires during the assembly.

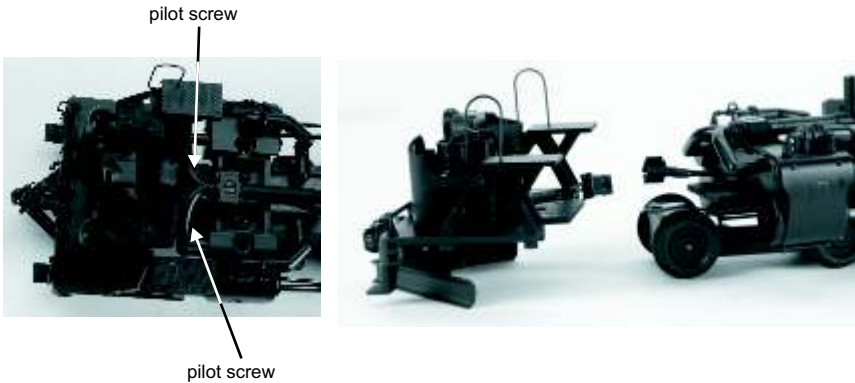

Figure 11



Figure 12

Self Charging Battery Back-Up

The two special AA size 1.5v NiCad self-charging batteries recharge continuously during train operation and should last for up to five years. The batteries are dry battery that should not leak or cause any damage to your engine. Depending upon when your engine was built, they may need to be charged right out of the box. If engine sounds seem distorted or garbled at low voltages or become silent when power from the transformer is turned off, test the batteries to determine whether they should be recharged or replaced.

Test: Put the engine in neutral and leave the track voltage at 10-12 volts (high enough for the lights to shine brightly and the engine to move steadily) for 15 minutes.

Recharge: If the sounds are improved at the end of the 15-minute test charge, the batteries charge has run down and can be recharged. There are a number of ways you can do this:

Leave the engine in neutral with track voltage at 10-12 volts for 6-7 hours so the batteries can fully recharge (if your engine has a smoke unit, be sure it is turned off).

Use M.T.H.'s battery recharger (sold separately) that plugs into a wall outlet and a special port under the water hatch in the tender to recharge the batteries overnight without leaving it on the track.

Replace: If the sounds are not improved at the end of the 15-minute test charge, it is time to replace the batteries. Available through M.T.H. Parts.

DO NOT substitute alkaline batteries for these NiCad batteries. Using alkaline batteries in this system can result in damage to the PS 2.0 circuit board and/or the batteries.

Do not use alkaline batteries for testing or checking purposes for the 3-Volt PS2 boards. Using alkaline batteries will damage the 3-Volt battery charging circuit.

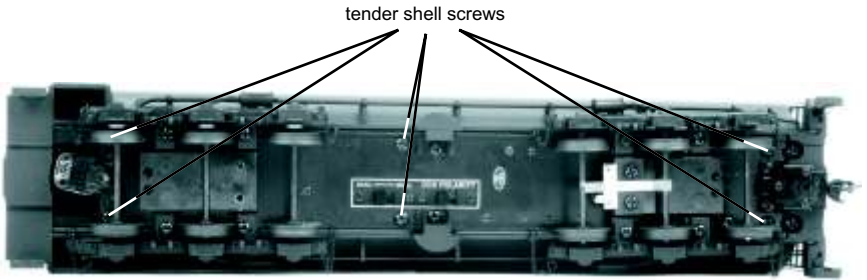

Figure 13

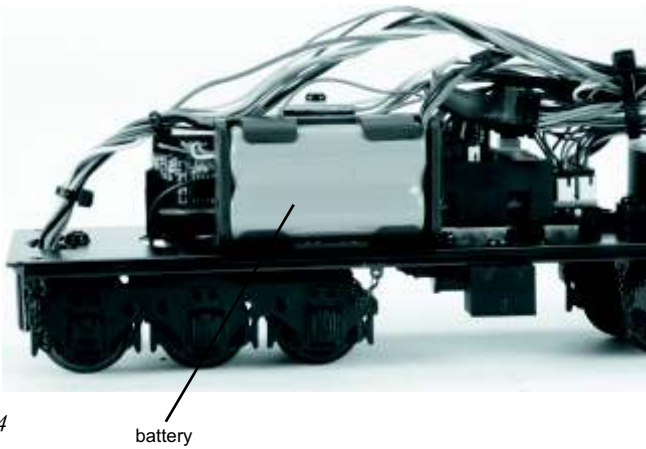

Figure 14

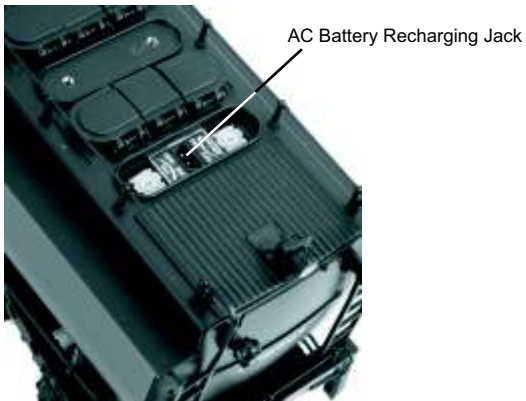

Figure 15

ProtoSmoke® Unit Operation

This Premier steam locomotive contains a self-powered smoke unit that outputs smoke through the smokestack on the roof of the engine. The smoke unit is essentially a small heating element and wick that soaks up and then heats a mineral oil-based fluid that emits a harmless smoke. The smoke is then forced out of the stack by a small electric fan. Smoke volume is controlled by the Proto-Sound 2.0 system.

With a few easy maintenance steps, you should enjoy trouble-free smoke unit operation for years.

When preparing to run this engine, add 15-20 drops of smoke fluid through the smokestack (see Fig. 16). We recommend M.T.H. ProtoSmoke, Seuthe, LGB, or LVTS fluids. Do not overfill the unit or the fluid may leak out and coat the interior engine components.

If you choose not to add the fluid (or have already added the fluid but choose to run smoke-free), turn off the smoke unit switch located under the water hatch on the tender (see Fig. 17). Failure either to add fluid to the unit or to turn it off may damage the smoke unit heating element and/or wick material.

When the smoke output while running the engine begins to diminish, add another 10-15 drops of smoke fluid or turn the smoke unit off.

When storing the unit for long periods of time, you may want to add about 15 drops of fluid to prevent the wick from drying out.

After removing the engine from storage, add another 25 drops of fluid, letting the wick soak up the fluid for 15 minutes prior to operation.

If you experience poor or no smoke output when the smoke unit is on and has fluid, check the wick to see if it has become hard, blackened, and unabsorbent around the heating element. To remove the smoke unit you will first have to remove the boiler shell (by removing the body mounting screws shown in Fig. 9 on pg. 15), board and bracket that block the smoke unit assembly from being accessed.



Figure 16

Smoke unit ON/OFF switch



Figure 17

ProtoSmoke® Unit Operation

1. Unplug the two wiring harnesses from the board mounted to the inside of the boiler and behind the smoke unit. 2. Remove the two screws securing the smoke unit inside the shell as seen in Fig. 18.

3. With the board free of the mounting screws, slide the assembly out of the boiler as seen in Fig. 18.

4. Once the unit is freed, remove the inspection cover (Fig. 19). Inspect the wick; if it is darkly discolored and hard, it should be replaced.

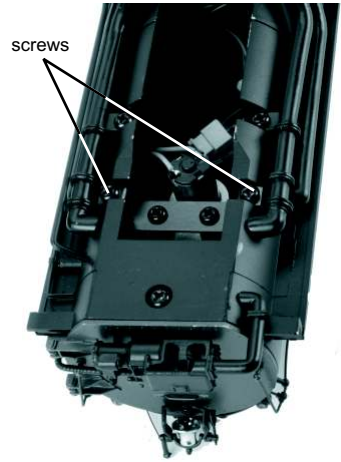

Figure 18

Replacement parts and wick replacement instructions are available directly from the M.T.H. Parts Department phone: 410-381-2580; e-mail: parts@meth-railking.com; 7020 Columbia Gateway Drive, Columbia MD 21046-1532

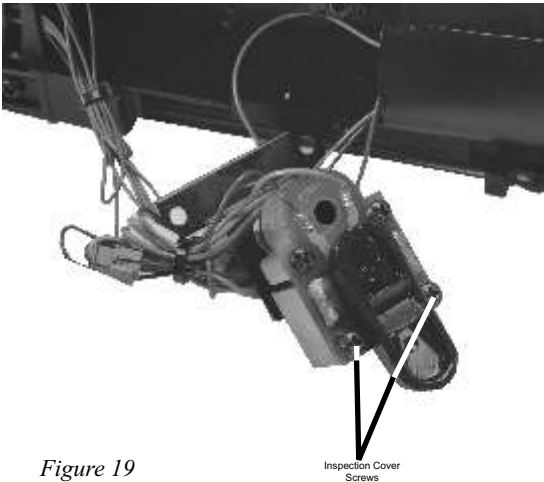

Figure 19

Troubleshooting Proto-Sound® Problems

Although Proto-Sound 2.0 has been designed and engineered for ease of use, you may have some questions during initial operation. The following table should answer most questions. If your problem cannot be resolved with this table, contact M.T.H. for assistance (telephone: 410-381-2580; fax: 410-423-0009; service@mth-railking.com, 7020 Columbia Gateway Drive, Columbia MD 21046-1532).

Starting Up	Remedy
<p>When I first turn the power on, the engine will not begin to run. I have to turn the throttle off and then on again to get the engine to operate.</p> <p>When I apply power all of the lights do not come on. Or the lights come on, but the engine will not move when I cycle the reverse unit.</p>	<p>This is normal behavior. To prevent accidental high-speed start-ups, Proto-Sound 2.0 is programmed to start up in neutral anytime track power has been turned off for several seconds. See the "Basic Operation" section for more details.</p> <p>The drawbar connector may not be seated properly. Make sure the drawbar is properly connected.</p>
Whistle/Horn	Remedy
<p>When I press the whistle/horn button, the bell comes on instead.</p>	<p>Reverse the transformer leads.</p>
<p>I can't get the horn to blow when I press the whistle button.</p>	<p>You may be pressing the button too quickly. Try pressing the whistle/horn button more slowly, taking approximately one full second to fully depress the button.</p>
Bell	Remedy
<p>When I press the whistle button, the bell sounds.</p>	<p>Reverse the transformer leads.</p>
<p>I can't get the bell to ring when I press the bell button.</p>	<p>You may be pressing the button too quickly. Try pressing the bell button more slowly, taking approximately one full second to fully depress the button.</p>
<p>The bell won't work on a separate bell button.</p>	<p>Check the wiring of the separate button.</p>
Coupler	Remedy
<p>When I try to fire the coupler, FYS starts.</p>	<p>You are waiting too long between whistle button presses.</p>
<p>The Proto-Coupler won't let the engine uncouple on the fly.</p>	<p>Try lubricating the coupler knuckle with a dry graphite lubricant. Do NOT use oil.</p>
<p>The coupler does not fire or stay coupled.</p>	<p>The coupler needs to be cleaned. Wipe with denatured alcohol (not rubbing alcohol) and let dry.</p>

Cab Chatter	Remedy
Sometimes the Cab Chatter sounds don't play.	Cab Chatter plays only in neutral at random intervals.
Lock-out	Remedy
I can't get the engine to run after I power up the transformer. It sits	The engine is locked into the neutral position. Follow the procedure in the "Lock into a Direction" section.
The engine won't lock into forward, neutral, or reverse.	Engine speed must be below 10 scale mph (approx. 10 volts or less in conventional mode).
Volume	Remedy
The sounds seem distorted, especially when the whistle or bell is activated.	Proto-Sound 2.0 volume is set too high. Turn the volume control knob on the bottom of the chassis counter-clockwise to reduce the volume.
Battery	Remedy
The engine will not leave the initial neutral setting.	Check to be sure the battery is installed and fully charged. See the "Self-Charging Battery Back-Up" section.
I get no sounds when the engine shifts between directions.	The battery may be dead or need to be charged. See the "Self-Charging Battery Back-Up" section.
After I turn off my transformer, my engine continues to make sounds before quitting.	Proto-Sound 2.0 is designed to continue to sound for a few seconds after power to the track has been shut off.
FYS/PSA	Remedy
The FYS/PSA sounds occasionally repeat themselves.	Proto-Sound 2.0 has a built-in random number generator that randomly selects each sound clip to play. Because there are a limited number of sound clips available in each FYS/PSA sequence, it is probable that some of these sound clips will be repeated from time to time.

FYS/PSA	Remedy
Once in FYS/PSA, the engine doesn't go into reverse.	So that FYS/PSA effects can be as realistic as possible, Proto-Sound 2.0 disables the reversing unit whenever FYS/PSA is enabled. This way the engine remains still at its stop as the operator cycles through the FYS/PSA sequences.
When the FYS/PSA enters its last sequence the bell automatically comes on.	FYS/PSA is programmed to start ringing the bell at that point. After approximately 12 seconds it will automatically turn off.
When FYS/PSA is enabled, pressing the whistle and bell buttons has no effect.	Because FYS/PSA must control various effects in each sequence, Proto-Sound 2.0 takes control of these sound effects until you exit
I push the direction button but the next sound clip in the sequence does not play or the engine does not come out of FYS/PSA after fourth press of the direction button.	Each FYS/PSA clip must play for approx. 30 seconds before FYS/PSA will advance to the next step in the FYS/PSA cycle. Wait at least 30 seconds in each FYS/PSA sound clip before pressing the direction button.

Transformer Compatibility and Wiring Chart

Proto-Sound 2.0 is designed to work with most standard AC transformers. The chart below lists the many compatible transformers. Note that many of the operational commands described in these instructions require a bell button, so if your transformer does not have its own bell button, you should consider adding one to get the full benefit of the system. In addition, the chart details how the terminals on these transformers should be attached to your layout.

RECOMMENDED AC TRANSFORMERS					
Transformer Model	Center Rail	Outside Rail	Min/Max. Voltage	Power Rating	Transformer Type
MTH Z-500	Red Terminal	Black Terminal	0-18v	50-Watt	Electronic
MTH Z-750	Red Terminal	Black Terminal	0-21v	75-Watt	Electronic
MTH Z-1000	Red Terminal	Black Terminal	0-21v	100-Watt	Electronic
MTH Z-4000	Red Terminal	Black Terminal	0-22v	390-Watt	Electronic
Lionel 1032	U	A	5-16v	90-Watt	Standard
Lionel 1032M	U	A	5-16v	90-Watt	Standard
Lionel 1033	U	A	5-16v	90-Watt	Standard
Lionel 1043	U	A	5-16v	90-Watt	Standard
Lionel 1043M	U	A	5-16v	90-Watt	Standard
Lionel 1044	U	A	5-16v	90-Watt	Standard
Lionel 1053	U	A	8-17v	60-Watt	Standard
Lionel 1063	U	A	8-17v	60-Watt	Standard
Lionel LW	A	U	8-18v	75-Watt	Standard
Powermaster	U	A	8-18v	135VA	Electronic
All-Trol	Left Terminal	Right Terminal	0-24v	300-Watt	Electronic
Dallee Hostler	Left Terminal	Right Terminal			Electronic
Lionel LW	A	U	8-18v	75-Watt	Standard
Lionel KW	A or B	U	6-20v	190-Watt	Standard
Lionel MW	Outside Track Terminal	Inside Track Terminal	5-16v	50V.A.	Electronic
Lionel RS-1	Red Terminal	Black Terminal	0-18v	50V.A.	Electronic
Lionel RW	U	A	9-19v	110-Watt	Standard
Lionel SW	U	A	Unknown	130-Watt	Standard
Lionel TW	U	A	8-18v	175-Watt	Standard
Lionel ZW	A,B,C or D	U	8-20v	275-Watt	Standard
Lionel Post-War Celebration Series ZW	A,B,C or D	Common	0-20v	135/190 Watt	Electronic

* Conventional Mode Only

Recommended DC Power Supplies

Proto-Sound 2.0 is designed to work with most standard DC power supplies and AC transformers. The following charts lists the recommended DC and AC transformers. Note that many of the AC operational commands described in these instructions require a bell button, so if your AC transformer does not have its own bell button, you should consider adding one to get the full benefit of the system. In addition, the chart details how the terminals on these transformers should be attached to your layout. DC transformers employing PWM (pulse width modulation) should not be used with the separately sold DCS system.

Transformer Model	Min/Max. Voltage	Power Rating	Transformer Type
MRC Controlmaster 20	0-20v	100 Watt	Electronic
PH Hobbies PS5	0-20v	100 Watt	Electronic
PH Hobbies PS10G	0-20v	180 Watt	Electronic
BridgeWorks Mag-15	0-24v	300 Watt	Electronic
BridgeWorks Magnum 200	0-24v	300 Watt	Electronic
BridgeWorks Magnum 400	0-24v	300 Watt	Electronic
BridgeWorks Magnum 1000	0-24v	300 Watt	Electronic
LGB Jumbo 50101	0-24v	240 Watt	Electronic

Additional Features Accessible With The DCS Remote Control System

(Additional equipment required)

While conventional mode operation of a Proto-Sound 2.0 engine yields wonderfully realistic sound and several train control features, command mode operation allows the user to access a world of command functions never before accessible to O Gauge railroaders. With the addition of the DCS Remote Control System (including a DCS remote handheld and Track Interface Unit) users gain many advanced features, including:

- **DCS Proto-Speed Control** - Establishes desired locomotive speed in scale miles per hour increments via a thumbwheel control and allows operator to set maximum speed and acceleration/deceleration rates
- **ProtoSmoke® Variable Output Control** - Controls how much smoke each engine outputs and matches smoke to locomotive speed
- **Locomotive Lighting Control** - Controls locomotive headlights, marker and interior lights, beacon lights, ditch lights, and MARS lights
- **Emergency Stop**-Single button push stops all Proto-Sound 2.0 trains but does not turn off the power
- **One Touch Global Mute/UnMute**-Single button mutes or unmutes all DCS-controlled locomotives' user-defined actions, including sound, lights, and smoke
- **Proto-Dispatch Operation**-Public Address-like feature allows users to speak through locomotive speaker during operation
- **Proto-Cast**-Allows users to play audio recordings through locomotive speaker during operation
- **Proto-Doppler Sound Effects Set Up**-Users can configure locomotive for Doppler Operation, including setting distance points for Doppler start, repeat, and stop modes
- **Independent Volume Control of Engine Sounds, Bell, Horn & Whistle for each Locomotive**
- **Control up to 50 different DCS-Equipped Locomotives at one time with multiple TIUs**
- **Proto-Effects™ Set Up**-User can select individual Proto-Effects™ operations to be active or inactive, including cab chatter, train wreck sounds, coupler sounds, **Direction Control Set Up**-User can set initial individual start-up direction (start in forward or reverse) for double-heading operations
- **Locomotive Consist Set-up**-User can determine locomotive values for consist make-ups, allowing multiple locomotives belonging to a consist to operate together

Service & Warranty Information

How to Get Service Under the Terms of the Limited One-Year Warranty

When you suspect an item is defective, please check the operator's manual for standard operation and troubleshooting techniques that may correct the problem. Additional information may be found on the M.T.H. Website. Should you still require service, follow the instructions below to obtain warranty service.

First, e-mail, write, call or fax a M.T.H. Authorized Service Center (ASC) in your area to obtain Repair Authorization. You can find the list of ASCs on the M.T.H. Website, www.mth-railking.com. Authorized Service Centers are required to make warranty repairs on items sold *only* from that store; all other repairs may-- or may not be done at the store's own discretion. If you did not purchase the item directly from the ASC, you will need to select a National Authorized Service Center (NASC). These centers are compensated by M.T.H. to perform warranty service for any customer whose repair qualifies for warranty service. A list of NASC retailers can be located on the M.T.H. Website or by calling 410-381-2580. Should the warranty no longer apply, you may choose either an ASC or NASC retailer to service your M.T.H. Product. A reasonable service fee will be charged.

CAUTION: Make sure the product is packed in its original factory packaging including its foam and plastic wrapping material to prevent damage to the merchandise. There is no need to return the entire set if only one of the components is in need of repair *unless otherwise instructed by the Service Center*. **The shipment must be prepaid and we recommend that it be insured. A cover letter including your name, address, daytime phone number, e-mail address (if available), Return Authorization number (if required by the service center, a copy of your sales receipt and a full description of the problem must be included to facilitate the repairs. Please include the description regardless of whether you discussed the problem with a service technician when contacting the Service Center for your Return Authorization.**

Please make sure you have followed the instructions carefully before returning any merchandise for service. Authorized M.T.H. Service Centers are independently owned and operated and are not agents or representatives of M.T.H. Electric Trains. M.T.H. assumes no responsibility, financial or otherwise, for material left in their possession, or work done, by privately owned M.T.H. Authorized Service Centers. If you need assistance at any time email MTH Service at service@mth-railking.com, or call 410 381-2580.

Limited One-Year Warranty

All M.T.H. products purchased from an Authorized M.T.H. Train Merchant are covered by this warranty.

See our website at www.mth-railking.com or call 410-381-2580 to identify an Authorized M.T.H. Train Merchant near you.

M.T.H. products are warranted for one year from the date of purchase against defects in material or workmanship, excluding wear items such as light bulbs, pick-up rollers, batteries, smoke unit wicks, and traction tires. We will repair or replace (at our option) the defective part without charge for the parts or labor, if the item is returned to an M.T.H. Authorized Service Center (ASC) or M.T.H. National Authorized Service Center (NASC) within one year of the original date of purchase. This warranty does not cover damages caused by improper care, handling, or use. Transportation costs incurred by the customer are not covered under this warranty.

Items sent for repair must be accompanied by a return authorization number, a description of the problem, and **a copy of the original sales receipt from an Authorized M.T.H. Train Merchant**, which gives the date of purchase. If you are sending this product to an Authorized Service Center, contact that Center for their return authorization.

This warranty gives you specific legal rights, and you may have other rights that vary from state to state. Specific questions regarding the warranty may be forwarded to M.T.H. Directly.

Service Department:
M.T.H. Electric Trains
7020 Columbia Gateway Drive
.Columbia MD 21046-1532