

## OPERATING

### INSTRUCTIONS

PLEASE READ BEFORE USE

## Tinplate Traditions® 400E Contemporary Steam

Freight Yard Sounds Operating Instructions



Thank You for purchasing the 400E Contemporary Steam with Freight Yard Sounds. The engine's durable Tinplate body is sized for operation on Standard Gauge Track. This Standard Gauge Tinplate Traditions® Steam Engine contains state-of-the-art electronics with many built-in automatic features for exciting operation. Despite these advanced features, the locomotive is easy to operate with any compatible standard AC transformer that is equipped with whistle and bell buttons (see the compatibility chart on page 15), and is compatible with most other 3-rail Standard Gauge locomotives, rolling stock, and accessories.

This locomotive is equipped with Proto-Sound 2.0 with Digital Command System (DCS). This new system will allow you to operate your locomotive in Command mode (when used with the DCS Remote Control System, sold separately) or Conventional mode. Conventional operating features are described in the following pages, while the DCS operating features are covered in the set of operating instructions that accompanies the DCS equipment. Conventional Mode operation of this locomotive is much simpler than operation of original Proto-Sound engines. For your own safety and that of your equipment, please read the instructions before you operate this engine.



**WARNING:** Do not lift this engine by its handrails. They cannot support the weight of the engine.

# TABLE OF CONTENTS

---

## Set Up

Lubrication and Greasing Instructions .....3

## Basic Operation

Throttle .....6  
Operation Buttons .....6  
Volume Control .....6

## Proto-Sound® 2.0

Activating Proto-Sound 2.0 Conventional Mode Features .....7  
Freight Yard Sounds (FYS) .....8  
Tips on Using FYS .....9  
Speed Control .....9  
Lock into a Direction .....10  
Reset to Factory Defaults .....10  
Automatic Sounds .....10

## Maintenance

Smoke Unit Operation .....11  
Replacing Smoke Unit Wick .....11  
Light Replacement .....12  
Self-Charging Battery Back-Up .....12  
Removing The Battery .....13  
Troubleshooting .....14  
Transformer Compatibility Chart .....15  
Additional Features with DCS Remote Control System .....16

## SERVICE AND WARRANTY INFORMATION

### **CAUTION: Electrically Operated Product:**

Not recommended for children under 10 years of age. M.T.H. recommends adult supervision with children ages 10 - 16. As with all electric products, precautions should be observed during handling and use to reduce the risk of electric shock.



### **WARNING: When using electrical products, basic safety precautions should be followed including the following:**

- Read this manual thoroughly before using this device.
- M.T.H. recommends that all users and persons supervising use examine the hobby transformer periodically for conditions that may result in the risk of fire, electric shock, or injury to persons, such as damage to the primary cord, plug blades, housing, output jacks or other parts. In the event such conditions exist, the transformer should not be used until properly repaired.
- As with all electrical appliances, this product should not be left in operation when unattended.

**If you have problems you cannot resolve by using these directions contact**

e-mail: [custserv@nth-railking.com](mailto:custserv@nth-railking.com) or phone: 410-381-2580

# Set Up

## Lubricating the Locomotive

Use motor oil (10W-40 or 10W-30) for lubrication. Apply oil sparingly, using a toothpick or similar applicator. Before beginning, please be sure to have several toothpicks and cotton swabs handy to apply oil and clean up the excess. Familiarize yourself with the location of the oiling points (see Fig. 1) before beginning. Apply oil before operating and after every seven hours of operation.

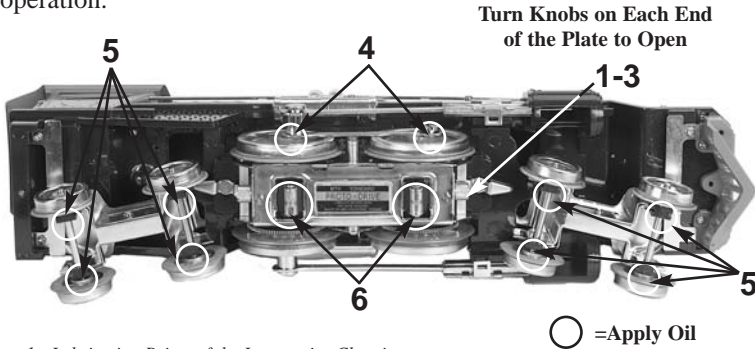
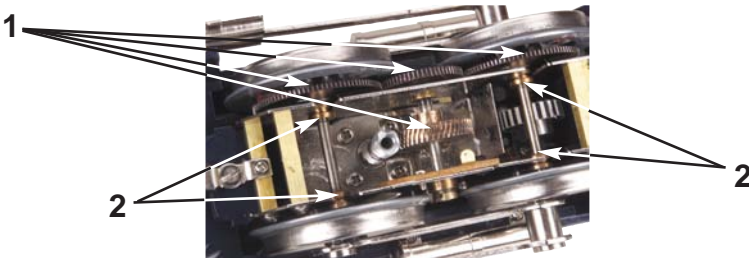

Figure 1: Lubricating Points of the Locomotive Chassis



### Lubricating the Wheel Gears (Fig. 1, #1)

Slowly turn the drive wheels by hand and apply lithium based grease to the wheel gears until all teeth on all four gears are moist. Wipe away excess grease with a cotton swab.

### Lubricating the Drive Axles (Fig. 1, #2)

Position one end of the locomotive downward so that you can see one of the drive axles on each motor. Using a toothpick or length of wire, carefully apply two drops of oil to the axles at all four bronze bearings.

Turn the locomotive around so that you can see the other two drive axles. Carefully apply two drops of oil on the axles at the bronze bearings.

**Lubricating the Internal Gearing and Flywheel Bearings (Fig. 1, #3)**

Remove the two thumb screws and remove the gearbox cover to expose the gears and flywheel. Apply lithium based grease to the gears and two drops of oil to each of the flywheel bearings.

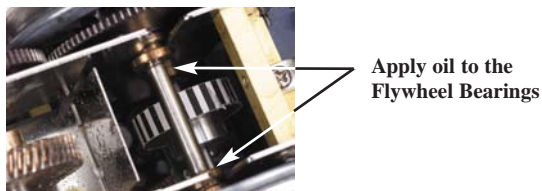

**Lubricating the Side Rods (Fig. 1, #4)**

Apply a drop of oil at each of the screws that attach the side rods to the drive wheels. Wipe away excess oil with a cotton swab.

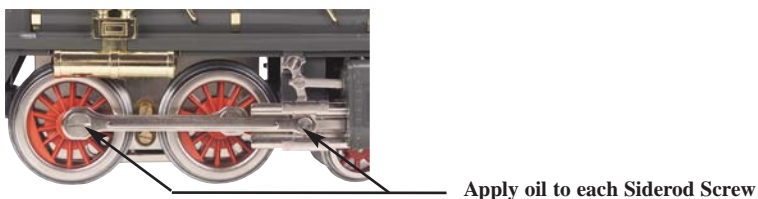

**Lubricating the Leading and Trailing Trucks (Fig. 1, #5)**

Apply a drop of oil to the axle holes and to each of the side axle bushings in the leading and trailing trucks. Wipe away excess oil with a cotton swab.

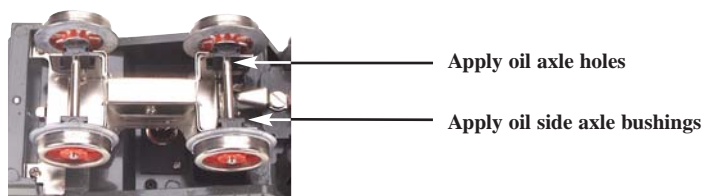

**Lubricating the Pickup Rollers (Fig. 1, #6)**

Apply a small drop of oil at the axles of the pickup rollers. Wipe away excess oil with a cotton swab. The rolling surface should be free of oil.

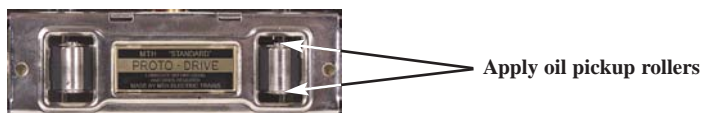

## Lubricating the Tender (Fig. 2)

Add a single drop of motor oil to all twelve wheels at the axle. Apply a small drop of oil at the axles of the pick-up rollers. Wipe away excess oil with a cotton swab. The rolling surface should remain free of oil.

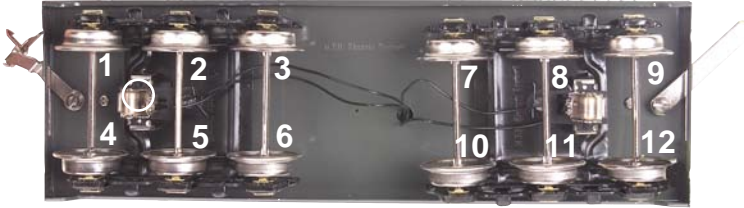
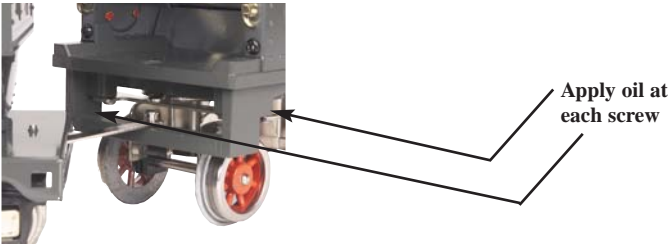

Figure 2: Lubricating Point of the Locomotive Tender

## Connecting the Engine and Tender

Use the draw bar to secure the engine and tender together.



## Priming the Smoke Unit

1. Prime the operating smoke unit with smoke fluid before operating. Add 15-20 drops of smoke fluid through the smokestack (see Fig. 3), then gently blow into the stack to eliminate any air bubbles in the fluid.
2. If you choose not to prime the unit with fluid, turn the smoke unit switch located under the cab to the OFF position (see Fig. 4). Running the engine without a primed smoke unit may cause damage. See the "Smoke Unit Operation" section of this book for more information on smoke unit maintenance.

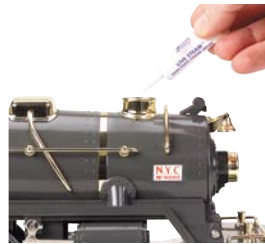

Figure 3



Figure 4

# Basic Operation

---

**Throttle** - Throttle up the power to your track. Give enough power so that the engine's headlight shines brightly. Then put the engine into motion by either firmly pressing the Direction button on your transformer or remote once or decreasing the throttle to off then increasing the throttle until the engine begins to move.

## Operation Buttons

Use the operation buttons on your transformer or remote as described below.

· **Horn/Whistle** - To sound the whistle, firmly press the Horn/Whistle button. The whistle will sound for as long as you continue to depress the button. It will stop when you release the button. The whistle has four different endings, depending on whether you hold the button for less than three seconds, three seconds, four seconds, or five seconds or longer.

· **Bell** - To sound the bell, firmly press and release the Bell button. To turn the bell off, press and release the Bell button again. The bell will continue to ring from the time you turn it on until you press and release the button again to turn it off.

· **Direction** - Your train is programmed to start in neutral. The first direction after neutral upon start-up is forward. Firmly press and release the Direction button to allow the engine to move forward. Just as you must stop your automobile between forward and reverse, this engine will not go directly from forward to reverse; it goes into neutral between directions. If the train has been moving forward, the first press of the Direction button will put the train from forward into neutral, the second press into reverse, the third press back into neutral, and the fourth back into forward. To prevent accidental high-speed start-ups, this engine is programmed to restart in neutral each time the track voltage is turned off for 25 seconds or more.

**Volume Control** - To adjust the volume of all sounds made by this engine, turn the master volume control knob located under the cab clockwise to increase the volume and counter-clockwise to decrease the volume.



Turn Clockwise to increase volume

Turn Counter Clockwise to decrease volume

# Proto-Sound 2.0 Operating Instructions

---

This manual contains the operating instructions for Proto-Sound 2.0 in conventional mode only. Instructions for accessing DCS command mode features accompany the DCS Remote Control System equipment.

Because Proto-Sound 2.0 is an all-new system developed by M.T.H.'s own research and development team, it operates differently from original Proto-Sound. Most Proto-Sound 2.0 features are automatically enabled, and reset has been eliminated, so there is no need to program features as with original Proto-Sound. Although the new system is easier to operate than original Proto-Sound, you should read these instructions thoroughly before using Proto-Sound 2.0 features in order to prevent harm to yourself or your equipment.

## Activating Proto-Sound 2.0 Conventional Mode Features:

Proto-Sound 2.0 features are activated by sequences of Bell and Whistle button pushes described below. Please read the full descriptions of each feature before using it. To use these buttons to activate features rather than to blow the whistle or ring the bell, you should tap the buttons very quickly with a ½-second pause between button presses. You may need to practice your timing to make this work smoothly.

Timing Chart				
Tap Bell Quickly	½ Sec. Pause	Tap Whistle Quickly	½ Sec. Pause	Tap Whistle Quickly
Total Time Lapse: 1 ½ Seconds				

Feature to Be Activated:	Button Code:
Freight Yard Sounds	1 Bell, 2 Whistles
Fire the Rear Coupler	1 Bell, 3 Whistles
Fire the Front Coupler	1 Bell, 4 Whistles
Speed Control On/Off	1 Whistle, 2 Bells (from Neutral only)
Lock into a Direction	1 Whistle, 3 Bells
Reset to Factory Defaults	1 Whistle, 5 Bells (from Neutral only)

TEMPLATE

**Freight Yard Sounds (FYS):**

Your engine is equipped with a sound package of freight yard sounds that you can play when you pull into a yard. **Each sequence described below will play as long as it is left on, randomly generating sounds, but be sure to allow approximately 30 seconds between the button pushes described below to allow the FYS sufficient time to run through each sequence.**

1. To cue the sound system to play the FYS, quickly but firmly tap the Bell button once followed by 2 quick taps of the Whistle button while the engine is moving. Tap the buttons quickly but allow approximately 1/2 second between each press.

**Cue Sound System to Play FYS**



Tap buttons quickly but allow 1/2 second between each press

2. Press the Direction button or drop and advance the throttle once to stop the engine. This will trigger the first sequence of FYS. The reverse unit is temporarily disabled so that the train will not move as you use the Direction button to trigger the sounds, and Proto-Sound 2.0 has disabled operator control over the Whistle and Bell buttons until the full FYS sequence is complete.

**Playing the FYS Sequence**

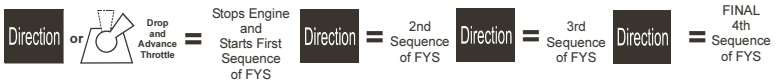

3. After waiting about 30 seconds for that sequence to run, press the Direction button again to trigger the second sequence of FYS
4. After about 30 seconds, press the Direction button again to trigger the third FYS sequence.
5. Again, after allowing about 30 seconds for that sequence to run, press the Direction button one more time to trigger the fourth and final FYS sequence. The FYS will continue, and within a few seconds, the engine will start and move out on its own at the current throttle setting, in the same direction it was traveling when you began the sequence. Once the bell turns off, the operator regains control of the transformer's bell and whistle buttons and can ring the bell or blow the whistle as usual.



## Tips on Using FYS

- You can terminate FYS at anytime by turning off power to the track for 15 seconds.
- You do not have to be in Forward to use FYS. At the conclusion of the full sequence, the train will pull away from the station in whatever direction you were going when you activated the feature.
- You can use FYS even if you are double-heading with another engine. If the second engine is not equipped with FYS at all, you must remember not to leave the throttle at a high voltage level once you have stopped the engine to run the FYS. Otherwise, the engine without FYS will begin vibrating on the track as its motors strain to move the train, since they cannot be automatically disabled during the FYS cycle. If the second engine is an original Proto-Sound engine equipped with FYS, you may choose to disable it when used in double-heading operations, so you will not experience competing FYS sounds. To disable FYS in an original Proto-Sound engine, see the operating instructions for that engine.
- FYS can be triggered from Neutral. It will operate the same as if triggered while in motion except that, at the conclusion of the FYS, the engine will depart in the next direction of travel, as opposed to the direction it was traveling before entering Neutral.

### Speed Control:

M.T.H. engines equipped with Proto-Sound 2.0 have speed control capabilities that allow the engine to maintain a constant speed up and down grades and around curves, much like an automobile cruise control. You can add or drop cars on the run, and the engine will maintain the speed you set.

While the engine is programmed to start with the speed control feature activated, you can opt to turn it off. This means the engine's speed will fall as it labors up a hill and increase as it travels downward. It is also affected by the addition or releasing of cars while on the run.

**To turn speed control on and off**, put the engine in neutral, then quickly tap the transformer's Whistle button one time then quickly tap the Bell button two times, allowing approximately ½ second to lapse between each quick

Place Engine in Neutral    Whistle    Bell    Bell    =    Two Whistle Blasts  
(indicates change is made)

Tap buttons quickly but allow ½ second between each press

TINPLATE

button press. Two whistle blasts will indicate that the engine has made the change. Repeat the 1 whistle, 2 bells code to return it to the other condition. **You will want to do this during the initial neutral upon start-up if you ever couple this engine to another engine that is not equipped with speed control to avoid damaging the motors in either engine.** Each time you shut down the engine completely, it will automatically turn speed control on.

**Note:** When speed control is turned off, the Proto-Sound 2.0 system will limit the volume in order to operate more smoothly at lower voltages. Full volume is restored upon reactivating speed control.

**Lock into a Direction:**

You can lock your engine into a direction (forward, neutral, or reverse) so that it will not change directions. To do this, put the engine into the direction you want (or into neutral to lock it into neutral), run it at a very slow crawl (as slowly as it will move without halting), and quickly but firmly tap the Horn button once followed by three quick taps of the Bell button, allowing approximately 1/2 second to lapse between each quick button press. Two horn blasts will indicate that the engine has made the change. The engine will not change direction (including going into neutral) until you repeat the 1 horn, 3 bells code to return the engine to its normal condition, even if the engine is kept without power for extended periods of time.



Tap buttons quickly but allow 1/2 second between each press

**Reset to Factory Defaults:**

To override the settings you currently have assigned to the engine and reset it to its factory defaults, while in Neutral tap the Whistle button quickly once, followed by five quick taps of the Bell button, allowing approximately 1/2 second to lapse between each quick button press. Two whistle blasts will indicate that the engine has made the change.



Tap buttons quickly but allow 1/2 second between each press

**Automatic Sounds:**

Certain Proto-Sound 2.0 sound effects automatically play in programmed conventional mode conditions:

- Squealing Brakes play any time the engine's speed decreases rapidly.
- Cab Chatter plays at random intervals when the engine idles in neutral.
- Engine Start-up and Shut-down sounds play when the engine is initially powered on or is powered off for five seconds or more.

# Maintenance

## Smoke Unit Operation

This Tinplate Traditions® steam locomotive contains a self-powered smoke unit that outputs smoke through the smokestack on the roof of the engine. The smoke unit is essentially a small heating element and wick that soaks up and then heats a mineral oil-based fluid that emits a harmless smoke. The smoke is then forced out of the stack by a small electric fan. Smoke volume is controlled by the Proto-Sound 2.0 system.

Follow the maintenance steps below for trouble-free smoke unit operation.

- When preparing to run this engine, add 15-20 drops of smoke fluid through the smokestack (see Fig. 3). We recommend M.T.H. ProtoSmoke, Seuthe, LGB, or LVTS fluids. Do not overfill the unit or the fluid may leak out and coat the interior engine components.



Fig 3

- If you choose not to add the fluid (or have already added the fluid but choose to run smoke-free), turn off the smoke unit switch located under the cab (see Fig. 4). **Failure either to add fluid to the unit or to turn it off may damage the smoke unit heating element and/or wicking material.**

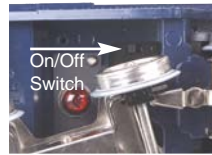

Fig 4

- When the smoke output while running the engine begins to diminish, add another 10-15 drops of smoke fluid or turn the smoke unit off.
- When storing the unit for long periods of time, you may want to add about 15 drops of fluid to prevent the wick from drying out.
- After removing the engine from storage, add another 25 drops of fluid, letting the wick soak up the fluid for 15 minutes prior to operation.

## Replacing the Smoke Unit Wick

If you experience poor or no smoke output when the smoke unit is on and has fluid, check the wick to see if it has become hard, blackened, and unabsorbent around the heating element. Remove the smoke unit inspection cover from the locomotive's body (see Fig. 5 on page 12). After removing the



Bad Wick



Good Wick

chassis and inspection cover screws, lift the inspection plate away and inspect the wick. If it is darkly discolored and hard, it should be replaced.

Replacement parts and wick replacement instructions are available directly from the M.T.H. Parts Department.

**Remove 4 screws to open smoke stack and replace wick**

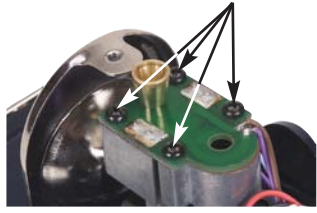

**Fig 5**

### Light Replacement Instruction

The locomotive's lights are controlled by a constant voltage circuit in the engine. They are easy to remove and replace when they burn out. Simply unscrew the bulb that needs to be replaced from its socket and replace it with another.

Follow the directions on how to remove chassis under Removing the Battery page 13 to access the bulbs.



**Replace the headlamps with M.T.H. CI-0000001 clear lamps.**



**Replace the red firebox lamps with M.T.H. CI-000007 red lamps.**

### Self-Charging Battery Back-Up

The special NiCad 7-cell 8.4v self-charging battery in this engine improves performance at any speed. It ensures that power to the sound system will remain on during directional changes or when travelling over dirty track or switches. The self-charging battery system is automatically turned on or off whenever track power is turned on or off.

Track power (when applied) recharges the battery, which should last for up to five years, and the special NiCad battery is a dry battery that should not leak or cause any damage to your engine. However, even this special battery will eventually wear down and need to be replaced. When you notice that your engine sounds seem distorted or garbled at low voltages or become silent when power from the transformer is turned off, test the battery to determine whether it should be recharged or replaced.

- Put the engine in neutral and leave the track voltage at 12 volts for 15 minutes

- If the sounds are improved at the end of the 15-minute test charge, the battery charge has run down and can be recharged. Do this by leaving the engine in neutral with track voltage at 12 volts for 6-7 hours so the battery can fully recharge. Or you can remove the battery and charge it in any standard slow charge battery recharger, following the recharger's directions.
- If the sounds are not improved at the end of the 15-minute test charge, it is time to replace the battery (see directions under Removing the Battery). Contact the M.T.H. Parts Department (phone: 410-381-2580; e-mail: parts@meth-railking.com; mail: 7020 Columbia Gateway Drive, Columbia MD 21046-1532) for a replacement battery. A standard 9v alkaline battery can be substituted until your replacement arrives, but since alkaline batteries cannot be recharged, it will eventually wear down.

**⚠ WARNING:** Do not use a 6-cell 7.2v battery like those found in most convenience stores.

## Removing the Battery

To Open the Chassis Remove 5 Screws

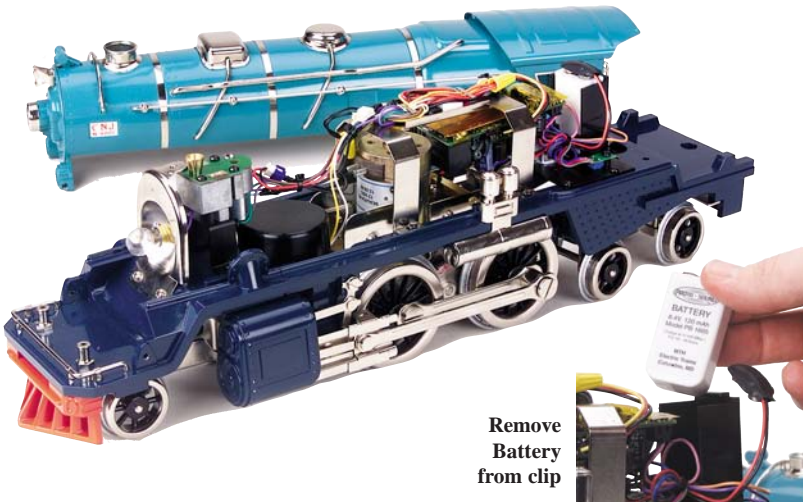
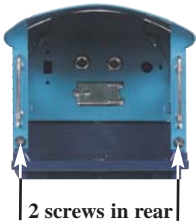

## Troubleshooting Proto-Sound® 2.0 Problems

Although Proto-Sound 2.0 has been designed and engineered for ease of use, you may have some questions during initial operation.

<b>Starting Up</b>	<b>Remedy</b>
When I first turn the power on, the engine will not begin to run. I have to turn the throttle off and then on again to get the engine to operate.	This is normal behavior. To prevent accidental high-speed start-ups, Proto-Sound 2.0 is programmed to start up in neutral anytime track power has been turned off for several seconds. See the "Basic Operation" section for more details.
<b>Whistle</b>	<b>Remedy</b>
When I press the whistle button, the bell comes on instead.	Reverse the transformer leads
I can't get the whistle to blow when I press the whistle button.	You may be pressing the button too quickly. Try pressing the whistle button more slowly, taking approximately one full second to fully depress the button.
<b>Bell</b>	<b>Remedy</b>
When I press the whistle button , the bell sounds.	Reverse the transformer leads.
I can't get the bell to ring when I press the bell button.	You may be pressing the button too quickly. Try pressing the whistle button more slowly, taking approximately one full second to fully depress the button.
The bell won't work on a separate bell button.	Check the wiring of the separate button.
<b>Cab Chat</b>	<b>Remedy</b>
Sometimes the Cab Chatter sounds don't play.	Cab Chatter plays only in neutral at random intervals.
<b>Lock-out</b>	<b>Remedy</b>
I can't get the engine to run after I power up the transformer. It sits still with the engine sounds running.	The engine is locked into the neutral position. Follow the procedure in the "Lock into a Direction" section.
The engine won't lock into forward, neutral, or reverse.	Engine speed must be below 10 scale mph (approx. 10 volts or less in conventional mode).
<b>Volume</b>	<b>Remedy</b>
The sounds seem distorted, especially when the whistle or bell is activated.	Proto-Sound 2.0 volume is set too high. Turn the volume control knob on the bottom of the chassis counter-clockwise to reduce the volume.
<b>Battery</b>	<b>Remedy</b>
The engine will not leave the neutral on start-up.	Check to be sure the battery is installed and fully charged. See the "Self-Charging Battery Back-Up" section.
I get no sounds when the engine shifts between directions.	The battery may be dead or need to be charged. See the "Self-Charging Battery Back-Up" section.
After I turn off my transformer, my engine continues to make sounds before quitting.	Proto-Sound 2.0 is designed to continue to sound for a few seconds after power to the track has been shut off.
<b>FYS</b>	<b>Remedy</b>
The FYS sounds occasionally repeat themselves.	Proto-Sound 2.0 has a built-in random number generator that randomly selects each sound clip to play. Because there are a limited number of sound clips available in each FYS sequence, it is probable that some of these sound clips will be repeated from time to time.
One in FYS, the engine doesn't go into reverse.	So that FYS effects can be as realistic as possible, Proto-Sound 2.0 disables the reversing unit whenever FYS is enabled. This way the engine remains still at its stop as the operator cycles through the FYS sequences.
When the FYS enters its last sequence the bell automatically comes on.	FYS is programmed to start ringing the bell at that point. After approximately 15 rings of the bell, it will automatically turn off.
When FYS is enabled, pressing the whistle and bell buttons has no effect.	Because FYS must control various effects in each sequence, Proto-Sound 2.0 takes control of these sound effects until you exit FYS.

## Compatibility

Proto-Sound 2.0 is designed to work with any standard AC transformer. The chart below lists the many compatible transformers. Note that many of the operational commands described in these instructions require a bell button, so if your transformer does not have its own bell button, you should consider adding one to get the full benefit of the system. In addition, the chart details how the terminals on these transformers should be attached to your layout.

### Transformer Compatibility and Wiring Chart

Transformer Model	Center Rail	Outside Rail	Min/Max. Voltage	Power Rating	Transformer Type
MTH Z-500	Red Terminal	Black Terminal	0-18v	50-Watt	Electronic
MTH Z-750	Red Terminal	Black Terminal	0-21v	75-Watt	Electronic
MTH Z-4000	Red Terminal	Black Terminal	0-22v	390-Watt	Electronic
Lionel 1032	U	A	5-16v	90-Watt	Standard
Lionel 1032M	U	A	5-16v	90-Watt	Standard
Lionel 1033	U	A	5-16v	90-Watt	Standard
Lionel 1043	U	A	5-16v	90-Watt	Standard
Lionel 1043M	U	A	5-16v	90-Watt	Standard
Lionel 1044	U	A	5-16v	90-Watt	Standard
Lionel 1053	U	A	8-17v	60-Watt	Standard
Lionel 1063	U	A	8-17v	60-Watt	Standard
All-Trol	Left Terminal	Right Terminal	0-24v	300-Watt	Electronic
Dallee Hostler	Left Terminal	Right Terminal			Electronic
Lionel LW	A	U	8-18v	75-Watt	Standard
Lionel KW	A or B	U	6-20v	190-Watt	Standard
Lionel MW	Outside Track Terminal	Inside Track Terminal	5-16v	50V.A.	Electronic
Lionel RS-1	Red Terminal	Black Terminal	0-18v	50V.A.	Electronic
Lionel RW	U	A	9-19v	110-Watt	Standard
Lionel SW	U	A	Unknown	130-Watt	Standard
Lionel TW	U	A	8-18v	175-Watt	Standard
Lionel ZW	A,B,C or D	U	8-20v	275-Watt	Standard
Lionel Post-War Celebration Series ZW	A,B,C or D	Common	0-20v	135/190 Watt	Electronic

\* Conventional Mode Only

### **Additional Features Accessible with the DCS Remote Control System:**

While conventional mode operation of a Proto-Sound 2.0 engine yields wonderfully realistic sound and several train control features, command mode operation allows the user to access a world of command functions never before accessible to O Gauge railroaders. With the addition of the DCS Remote Control System (including a DCS remote handheld and Track Interface Unit) users gain many advanced features, including:

- **DCS Proto-Speed Control** - Establishes desired locomotive speed in scale miles per hour increments via a thumbwheel control and allows operator to set maximum speed and acceleration/deceleration rates
- **Locomotive Lighting Control** - Remotely controls locomotive lights
- **Emergency Stop-Single** button push stops all Proto-Sound 2.0 trains but does not turn off the power
- **One Touch Global Mute/UnMute**-Single button mutes or unmutes all DCS-controlled locomotives' user-defined actions, including sound, lights, and smoke
- **Proto-Dispatch Operation**-Public Address-like feature allows users to speak through locomotive speaker during operation
- **Proto-Cast**-Allows users to play audio recordings through locomotive speaker during operation
- **Proto-Doppler Sound Effects Set Up**-Users can configure locomotive for Doppler Operation, including setting distance points for Doppler start, repeat, and stop modes
- **Independent Volume Control** of Engine Sounds, Bell, Horn & Whistle for each Locomotive
- **Proto-Effects™ Set Up**-User can select individual Proto-Effects™ operations to be active or inactive, including cab chatter, train wreck sounds, and wheel clickety-clack sounds
- **Direction Control Set Up**-User can set initial individual start-up direction (start in forward or reverse) for double-heading operations
- **Locomotive Consist Set-up**-User can determine locomotive values for consist make-ups, allowing multiple locomotives belonging to a consist to operate together
- **Query Locomotive Information**-User can query locomotive programming to learn locomotive address and engine data information, including scale miles traveled
- **User Can Query, Set and Operate Track and Accessory Interface Units** for Programming Digital Command Operations for Accessories and Track Switches
- **User Can Script, Record and Playback Train Routes**

Operating instructions for all DCS Command features will accompany the DCS remote control equipment.





# SERVICE & WARRANTY INFORMATION

## How to Get Service Under the Terms of the Limited One-Year Warranty

For warranty repair, do not return your product to the place of purchase. Instead, follow the instructions below to obtain warranty service, as our dealer network is not prepared to service the product under the terms of this warranty.

1. First, write, call or FAX M.T.H. Electric Trains, 7020 Columbia Gateway Drive, Columbia, MD 21046, (Tel: 410-381-2580; FAX: 410-423-0009; e-mail: [service@mth-railking.com](mailto:service@mth-railking.com)), stating when it was purchased and what seems to be the problem. You will be given a return authorization number to ensure that your merchandise will be properly handled upon its receipt.
2. **CAUTION:** Make sure the product is packed in its original factory packaging including its foam and plastic wrapping material so as to prevent damage to the merchandise. The shipment must be prepaid and we recommend that it be insured. A cover letter including your name, address, daytime phone number, e-mail address (if available), Return Authorization number, a copy of your sales receipt and a full description of the problem must be included to facilitate the repairs. Please include the description regardless of whether you discussed the problem with one of our service technicians when contacting M.T.H. for your Return Authorization number.
3. Please make sure you have followed the instructions carefully before returning any merchandise for service.

### Limited One-Year Warranty

All M.T.H. products purchased from an Authorized M.T.H. Train Merchant are covered by this warranty.

See our website at [www.mth-railking.com](http://www.mth-railking.com) or call 1-888-640-3700 to identify an Authorized M.T.H. Train Merchant near you.

M.T.H. products are warrantied for one year from the date of purchase against defects in material or workmanship, excluding light bulbs and traction tires. We will repair or replace (at our option) the defective part without charge for the parts or labor, if the item is returned to M.T.H. Electric Trains within one year of the original date of purchase. This warranty does not cover damages caused by improper care, handling, or use. Transportation costs incurred by the customer are not covered under this warranty.

Items sent for repair must be accompanied by a return authorization number, a description of the problem, and the original sales receipt from an Authorized M.T.H. Train Merchant, which gives the date of purchase. Call 410-381-2580, fax 410-423-0009, or e-mail the Service Department at [service@mth-railking.com](mailto:service@mth-railking.com) to obtain a return authorization number.

This warranty gives you specific legal rights, and you may have other rights that vary from state to state.

Service Department  
M.T.H. Electric Trains  
7020 Columbia Gateway Drive  
Columbia MD 21046-1532



TINPLATE